

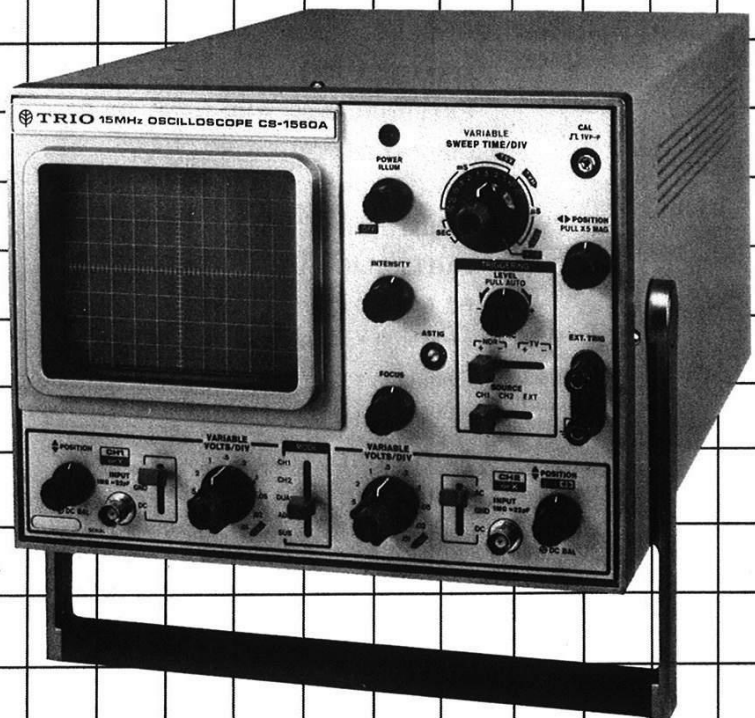

# TRIO SERVICE MANUAL CS-1560A

OSCILLOSCOPE

WORKSHOP USE ONLY  
NOT FOR SALE  
PROPERTY OF KENWOOD AUSTRALIA P/L



# OUTLINES/CONTENTS

## OUTLINES

MODEL CS-1560A is a dual-trace trigger sweep type oscilloscope equipped with a 130mm cathode ray tube (CRT) and integrated circuits. Due to its wide frequency range from DC to 15 MHz, sweeping speed from  $0.5\mu\text{s}/\text{div}$  to  $0.5\text{s}/\text{div}$ , and provision of TV synchronizing separator circuit, it is capable of dual-trace observation and measurement of TV video signals and various waveforms in general electronic devices and equipment.

## CONTENTS

SPECIFICATIONS .....	3
EXTERNAL VIEW AND NAME OF PARTS .....	4
CIRCUIT DESCRIPTIONS .....	5
TROUBLESHOOTING .....	7
ADJUSTMENTS .....	15
PARTS ALIGNMENT .....	19
PC BOARD	
X68-1190-00 .....	22
X73-1230-00 .....	23
X74-1090-00 .....	24
PARTS LIST .....	25
SCHEMATIC DIAGRAM .....	31

# SPECIFICATIONS

## CATHODE RAY TUBE

Type of Cathode Ray Tube 130BRB31 or C535P31B  
 Acceleration Voltage 2 kV

## VERTICAL AXIS (for both CH1 and CH2)

**Sensitivity** 10 mV/div ~ 20 V/div  $\pm 5\%$   
**Attenuator** 10 mV/div ~ 20 V/div, 1 - 2 - 5 step (1 div = 1 cm)  
 Precisely adjustable in all 11 ranges. Sensitivity error between ranges is  $\pm 5\%$ .

**Input Impedance** 1 M $\Omega$   $\pm 5\%$   
**Input Capacitance** 22 pF  $\pm 3\text{pF}$   
**Frequency Response** DC: DC ~ 15 MHz (Less than -3 dB)  
 AC: 2 Hz ~ 15 MHz (Less than -3 dB)

**Rising Time** Less than 23nsec  
**Overshoot** Less than 3% (at 100 kHz square wave)

**Cross-talk** Better than 70 dB at 1 kHz

**Operating Mode**  
**CH1** Channel 1 only.  
**CH2** Channel 2 only.  
**DUAL** 2-channel (CHOP and ALT are automatically selected by SWEEP TIME/DIV) 0.5  $\mu\text{s}/\text{div}$  ~ 0.5ms/div ALT (alternate sweep) 1ms/div ~ 0.5s/div CHOP (200 kHz switching)

**ADD** Arithmetic addition of 2 channels (CH1 + CH2)  
**SUB** Arithmetic subtraction of 2 channels (CH1 - CH2)

**CHOP Frequency** 200 kHz  $\pm 20\%$   
**Maximum Input Voltage** 600V p-p or 300V (DC + AC peak)

## SWEEP CIRCUIT

**Sweep System** Triggering sweep and auto sweep (free-running sweep at no-signal time)

**Sweep Time** 0.5  $\mu\text{s}/\text{div}$  ~ 0.5s/div  $\pm 5\%$  and "X-Y", 1 - 2 - 5 step Fine adjustment in all 19 ranges

**Magnifier** 5 times  $\pm 5\%$  (PULL x 5 MAG)  
**Linearity** Less than 3% (2  $\mu\text{s}/\text{div}$  ~ 0.5 s/div)  
 Less than 5% (0.5  $\mu\text{s}/\text{div}$  ~ 1  $\mu\text{s}/\text{div}$ )

## SYNCHRONIZATION

**Sync Input** CH1, CH2, EXT  
**Sync Selection**  
**NOR** Positive and negative  
**TV** Positive and negative (TVH and TVV are automatically switched by SWEEP TIME/DIV)

**TVH (TV-Line)** 0.5  $\mu\text{s}/\text{div}$  ~ 50  $\mu\text{s}/\text{div}$   
**TVV (TV-Field)** 0.1 ms/div ~ 0.5 s/div

**Sync Voltage**  
**CH1 and CH2** Amplitude on CRT screen, more than 0.5 div  
**EXT** More than 1V p-p  
**Sync Frequency** 20 Hz ~ 15 MHz

## HORIZONTAL AXIS (CH2 input)

**Operating Mode** X-Y mode is selected by SWEEP TIME/DIV  
**CH1** Y axis  
**CH2** X axis

**Sensitivity** Same as CH2 (10 mV/div ~ 20 V/div  $\pm 5\%$ )

**Frequency Response** DC: DC ~ 1 MHz (less than -3 dB)  
 AC: 2Hz ~ 1 MHz (less than -3 dB)

**Input Impedance** Same as CH2 (1 M $\Omega$   $\pm 5\%$ )  
**Input Capacitance** Same as CH2 (22pF  $\pm 3\text{pF}$ )  
**Calibrating Voltage** 1V p-p  $\pm 5\%$  (1 kHz square wave)

## LUMINANCE MODULATION

**Input Voltage** More than 20V p-p  
**Input Impedance** 470 k $\Omega$   $\pm 20\%$

## POWER SOURCE

**Power Supply Voltage** 100/120/220/240V  $\pm 10\%$  50/60 Hz  
**Power Consumption** 23W

## DIMENSIONS AND WEIGHT

**Width** 260 mm (277 mm)  
**Height** 190 mm (204 mm)  
**Depth** 384 mm (449 mm)  
 Figures in ( ) show maximum sizes.  
**Weight** 8.4 kg

## ACCESSORIES

**Probe** PC-27: 2 pcs.  
 Damping: 1/10  
 Input impedance: 10 M $\Omega$   
 Input capacitance: less than 18pF

**Pin-plug** Shorting type: 1 pc.  
 Non-shorting type: 1 pc.

**Instruction Manual** 1 copy

# EXTERNAL VIEW AND NAME OF PARTS

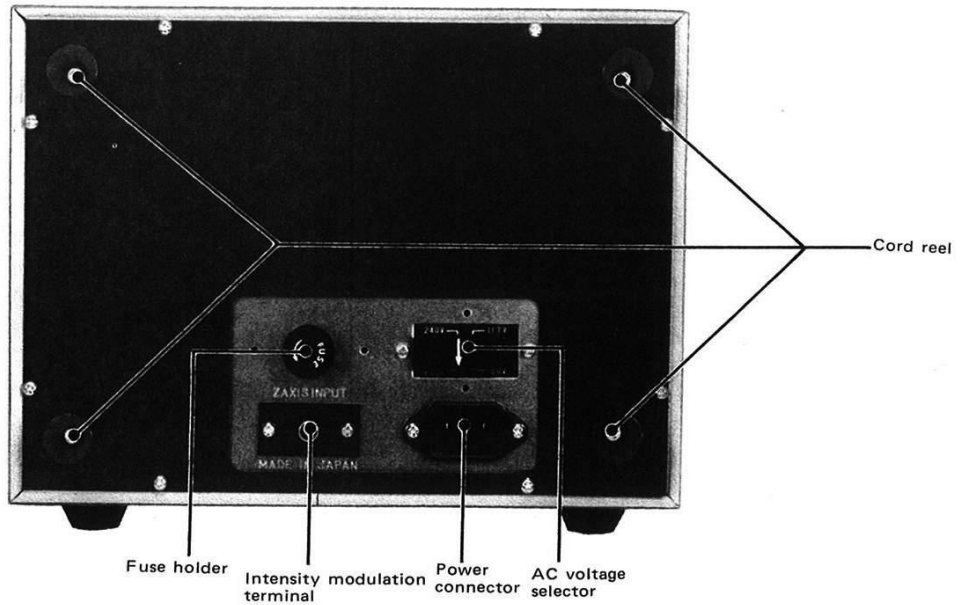
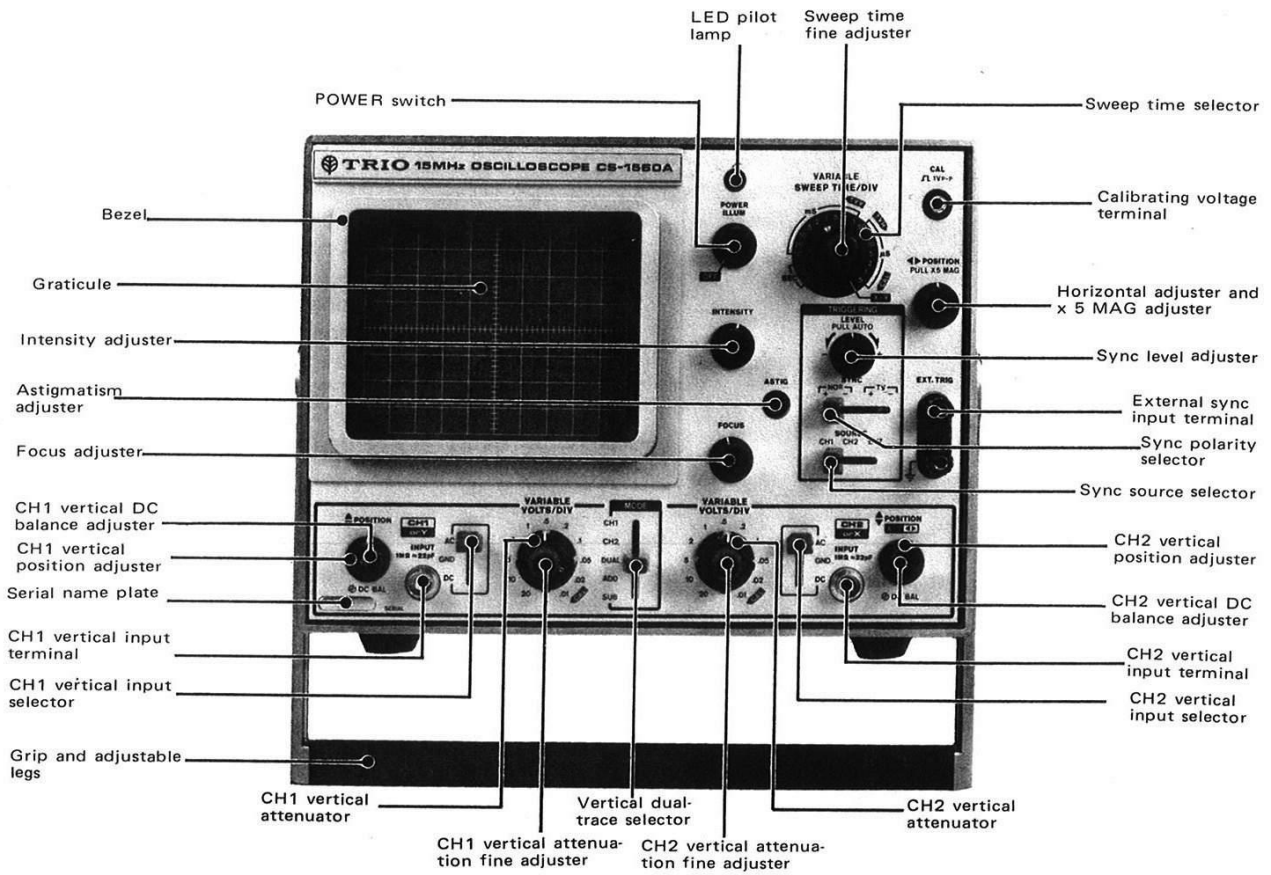

# CIRCUIT DESCRIPTIONS

Fig. 1 shows the block diagram of the oscilloscope. The circuit is shown in the circuit diagram given at the end of this manual.

## OUTLINES OF CIRCUITS

This oscilloscope is provided with two identical input attenuators and two vertical amplifiers. The input is attenuated to the required level, amplified at the pre-amplifier, and fed to the main vertical amplifier after proper switching. Changeover between CH1 and CH2 pre-amplifiers is accomplished by MODE switch which actuates the mode control logic circuit.

The input signal is finally fed to the output amplifier, so that the output is applied to the vertical deflection plate of CRT.

The horizontal circuit generates saw-tooth waveforms synchronized by the triggering signal from the vertical circuit or external source, which drives the horizontal amplifier while being applied to the horizontal deflection plate of CRT. During X-Y operation, CH2 vertical input signal is amplified by the pre-amplifier and is applied as horizontal signal to the horizontal amplifier. The 2kV high voltage power for CRT as well as the power for all other circuits is stabilized for reliable operation.

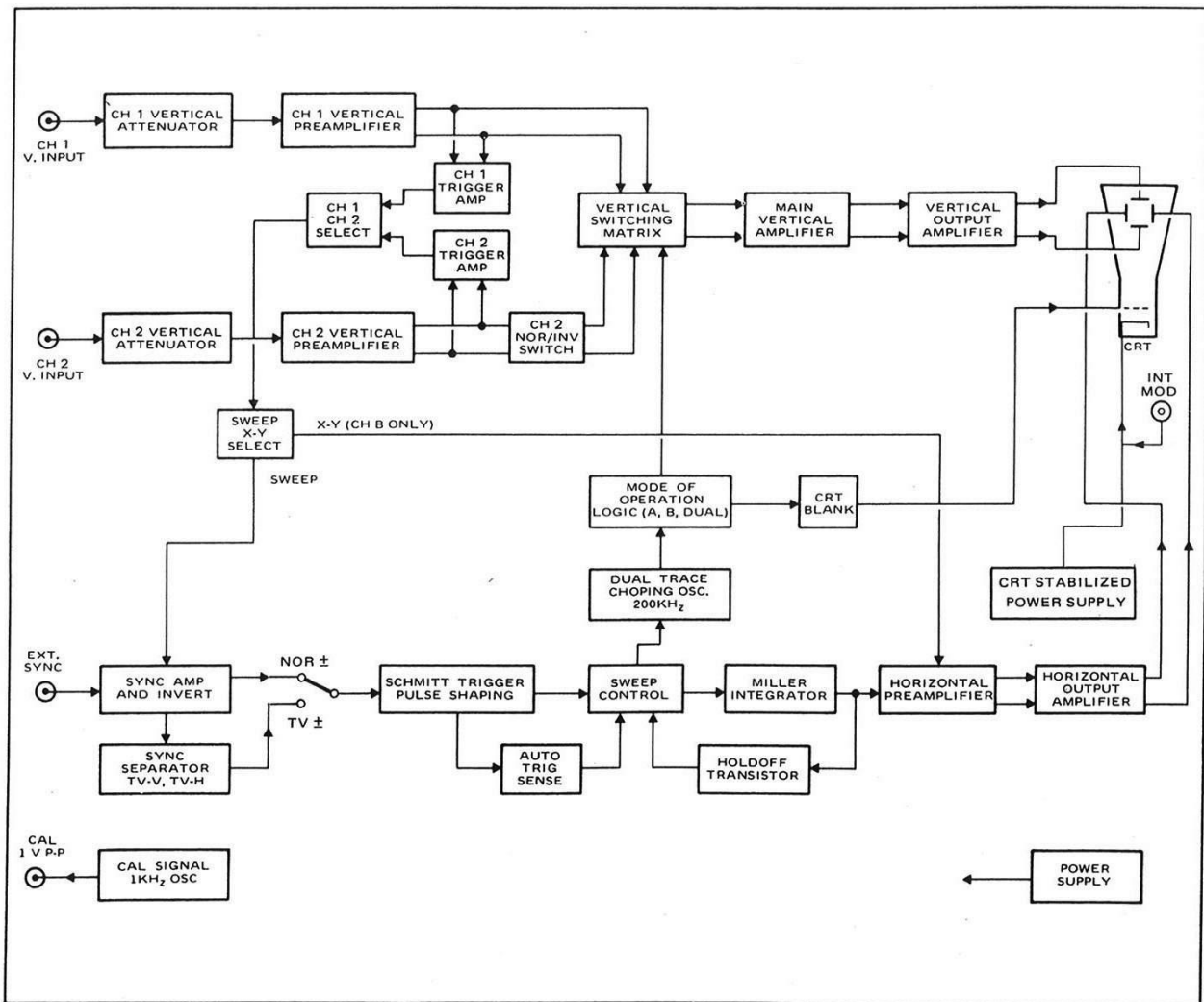

Fig. 1 Block Diagram, CS-1560A Dual-Trace Oscilloscope

## CIRCUIT DESCRIPTIONS

### VERTICAL AMPLIFIER

The pre-amplifiers for CH1 and CH2 are identical with each other in characteristics and functions. The vertical input signal fed from the BNC input terminal is controlled by the AC-GND-DC switch as necessary so as to be applied to the 1st attenuator. The output thus obtained is fed to the first-stage FET Q102 (Q111) through high input impedance. Because of the use of Q103 (Q112), DC voltage is well balanced against temperature variation. The output signal is then applied to the emitter follower circuit composed of Q104 and Q105 (Q113, Q114) and fed to the 2nd attenuator through low output impedance. The source circuit of the first source follower is provided with VR101a (VR103b) for DC balancing. The variable resistors VR105 and VR106 (VR108, VR109) are used as the attenuator balancers to avoid shifting of bright line when the attenuator is manipulated.

The output obtained from the 2nd attenuator is fed to Q106 and Q107 (Q115, Q116). The variable resistor VR102 (VR104) in this stage is used to adjust the gain, while VR101b (VR103b) is used to balance the DC level for the adjustment of the vertical position. This output is fed to the cascode amplifier consisting of Q108 and Q109 (Q117, Q118) together with a vertical switching matrix to reduce the mirror effect and obtain a sufficient gain. The variable resistor VR107 (VR110) connected to the emitter circuit of this stage adjusts the gain to the calibrated value when the vertical gain control is set in CAL position. After switching in the matrix circuit, the output is fed to the main drive amplifier composed of Q123, Q124, and IC103. The variable resistor VR114 is used for offset adjustment of IC103. When the MODE switch is set in SUB position, output is fed to the matrix circuit in reverse polarity.

This system is the same as that for the CH2 pre-amplifier. The output signal obtained from the emitter circuit of the first stage in the cascode amplifier is amplified at the trigger amplifier and then fed as a sync signal to the sync amplifier. In X-Y operation the CH2 trigger amplifier acts as the X amplifier.

The mode logic circuit which is controlled by the MODE switch, turns ON and OFF the vertical switching matrix circuit inserted between the CH1 and CH2 cascode amplifiers. With the MODE switch set to CH1 position, the CH1 pre-amplifier is turned ON while the CH2 pre-amplifier is OFF and thus only the signal of CH1 is fed to the following amplifying stage. For CH2 operation, the MODE switch should be set to CH2 position; the CH1 pre-amplifier is turned OFF and the signal of CH2 is fed to the following stage. In the case of DUAL operation, the signals of CH1 and CH2 are fed alternately to the following amplifying stages. This alternate switching function is effected by CHOP and ALT. The selection between CHOP and ALT is automatically accomplished by the SWEEP TIME/DIV control. During CHOP operation, CH1 and CH2 are switched alternately by 200 kHz signal, and in the ALT opera-

tion the signals of CH1 and CH2 are alternately switched for each sweep. In the SUB setting, the signal of CH2 is fed to CH1 in reverse polarity, thus generating a differential signal between CH1 and CH2. The output obtained is sufficiently amplified by the cascode-connected output amplifier composed of Q301 ~ Q305 and is then directly fed to the vertical deflection plate of CRT.

### SYNCHRONIZING CIRCUIT

The triggering signal, after selecting the type (CH1, CH2, or EXT) of sync voltage with the SOURCE switch, is fed to the differential sync amplifier of Q201 ~ Q204. In this amplifier, the input point is selected according to the polarity of the SYNC switch to determine the starting point of synchronization, either the rising point or the falling point of the waveform; also, the DC voltage corresponding to the position of the TRIG LEVEL (VR201) is added to the triggering signal to change the sweep starting point. With the SYNC switch S202 set to TV $\pm$ , the output is fed to TV sync separator circuit. In the TVH position, the peak point of pulse of horizontal sync signal is amplified and only the horizontal sync signal is fed to the following stage. In the TVV position, the integration circuit is connected and only the vertical sync signal is fed to the following stage. Changeover between TVH and TVV is automatically accomplished by the SWEEP TIME/DIV switch. The signal passing through the buffer in the emitter follower circuit is shaped into square waves by the 2-stage Schmidt trigger circuit consisting of IC201c, d and becomes clock pulses for the gate F.F. IC202. The gate F.F. is inverted by the clock pulses, in turn sets Q213 to OFF, and thus the Miller integrator becomes charged.

The Miller integrator determines the sweep time by the C/R time constant selected by the SWEEP TIME/DIV switch to obtain saw-tooth waves of excellent linearity. When the output from the Miller integrator fully rises, the hold-off F.F. is inverted and the sweep stops for the time determined by the hold-off time constant. When the hold-off time passes, the next clock pulse is set in standby mode and thereby the sweep returns to the original status.

The Miller integrator also detects the presence of triggering signal fed from the Schmidt trigger circuit to drive the AUTO circuit. With no triggering input, the output of AUTO circuit becomes low and, therefore, the gate F.F. starts automatic sweeping. With triggering input, the output of AUTO circuit becomes high and the gate F.F. synchronizes with clock pulses. The sweep time is adjustable with the variable resistor VR203 inserted in the time constant circuit of the Miller integrator, while the DC component in the Miller output is varied by VR202 to adjust the horizontal position.

The saw-tooth waves pass through SWEEP/XY SELECT and are fed to the horizontal amplifier where the signal is amplified to the specified horizontal deflection voltage, and then directly fed to the horizontal deflection plate

## CIRCUIT DESCRIPTIONS

of CRT. With SWEEP TIME/DIV set to X-Y position, SWEEP/XY SELECT is switched to separate the Miller integrator from the horizontal amplifier and thus the vertical CH2 input is applied as horizontal input to the horizontal amplifier. In CHOP operation, blanking effects are given with the use of the horizontal  $\bar{Q}$  output and the chop signal generator. In ALT operation, the effects are given by the  $\bar{Q}$  output.

### CRT CIRCUIT AND POWER CIRCUIT

An acceleration voltage of about 2 kV is required for operation of CRT. This voltage is generated by DC-DC converter and stabilized through the feedback type constant voltage circuit. The CRT circuit includes a negative feedback circuit and a DC regenerative circuit to prevent the change in high voltage due to increased luminance and to improve the rising characteristic of unblanking during high speed sweeping. The power circuit is fully stabilized. The use of a tracking regulator with IC OP amplifier keeps the main power supply ( $\pm 10V$ ) constant against variations in power voltage.

## TROUBLESHOOTING

### 1. REMOVING THE CASE (Refer to Fig. 2)

Remove the five screws from the top, bottom, and side walls of the case, using a Phillips head screwdriver.

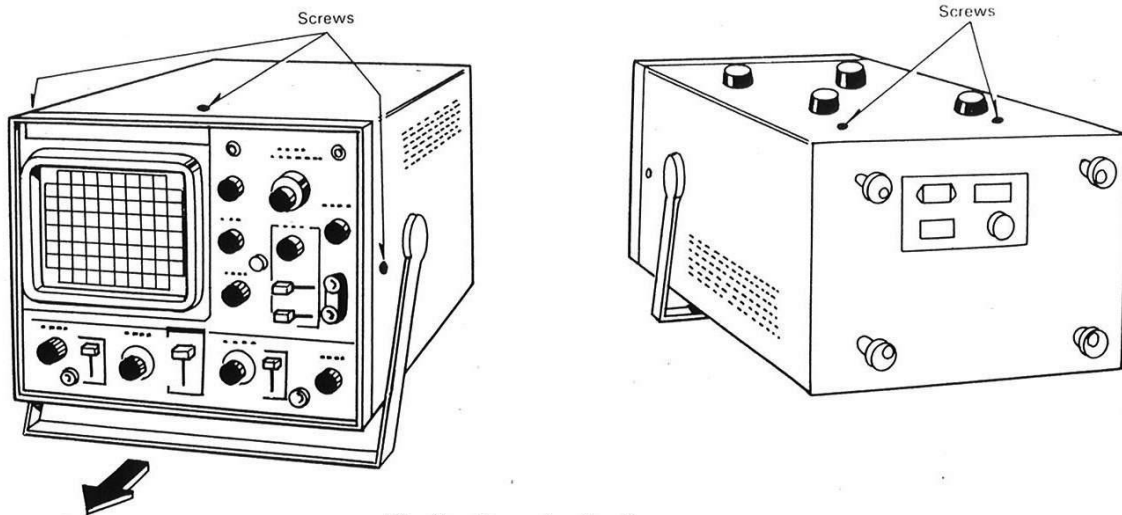

Fig. 2 Removing the Case

## TROUBLESHOOTING

### 2. REMOVING THE BEZEL (Refer to Fig. 3)

Since the bezel is mounted on the case through the four mold legs on its back, it can directly be removed without using any tool. However, the mold legs may be broken if unreasonable force is exerted carelessly. As shown in Fig. 3 (A), remove the two legs on the bottom side first. They should not be dismantled completely. They should be loosened so that part a of each leg's tip is unlocked as

shown in Fig. 3 (B). Then the remaining two legs on the top side can be dismantled. In dismantling these legs, only vertical force should be exerted always against the panel surface.

When mounting the bezel 1 on the case, as shown in Fig. 3 (C), get the two holes B and B' of the graticule engaged with the two bosses A and A' of the bezel 1. Then get them engaged with the two holes C and C' of the filter 3.

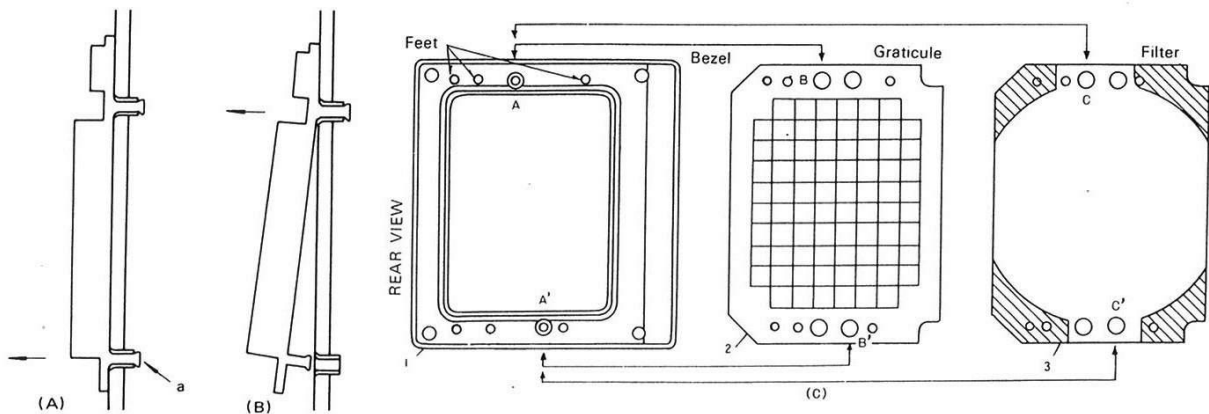

Fig. 3 Removing the Bezel

### 3. ADJUSTMENT OF CRT BRIGHT LINE AZIMUTH

- (1) Remove the case in accordance with the descriptions about REMOVING THE CASE.
- (2) Loosen the two screws of the CRT band which holds the neck part of CRT.
- (3) Turn the CRT through the two adjusting holes located in front of the CRT shield case so that the bright line can coincide with the horizontal line of the graticule.
- (4) Retighten the screws making sure that the bright line is in the horizontal position.

### 4. AC VOLTAGE SELECTOR

The oscilloscope may be operated from 100V, 120V, 220V, 240V, putting the AC voltage selector in place of another.

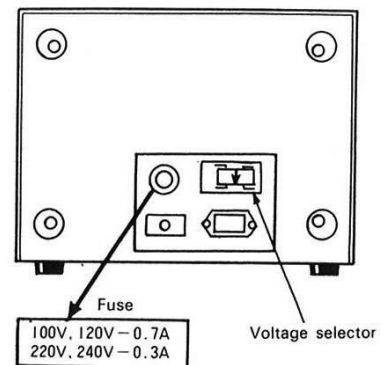
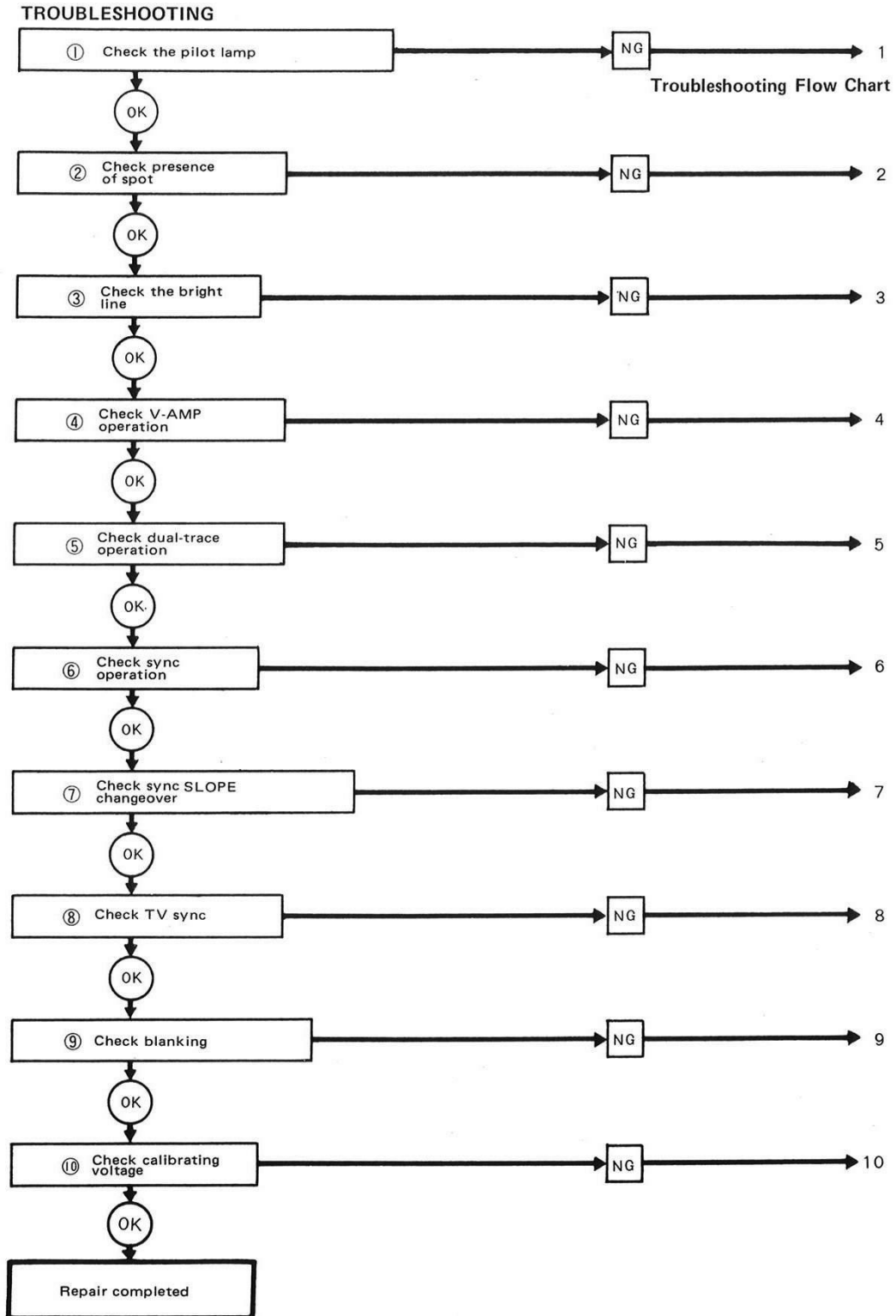

Fig. 4



# TROUBLESHOOTING



# TROUBLESHOOTING

**Notes:**

1. Parts without particular notes belong to the main body.
2. X73 ... denotes X73-1230-00.
3. X74 ... denotes X74-1090-00.
4. X68 ... denotes X68-1190-00.

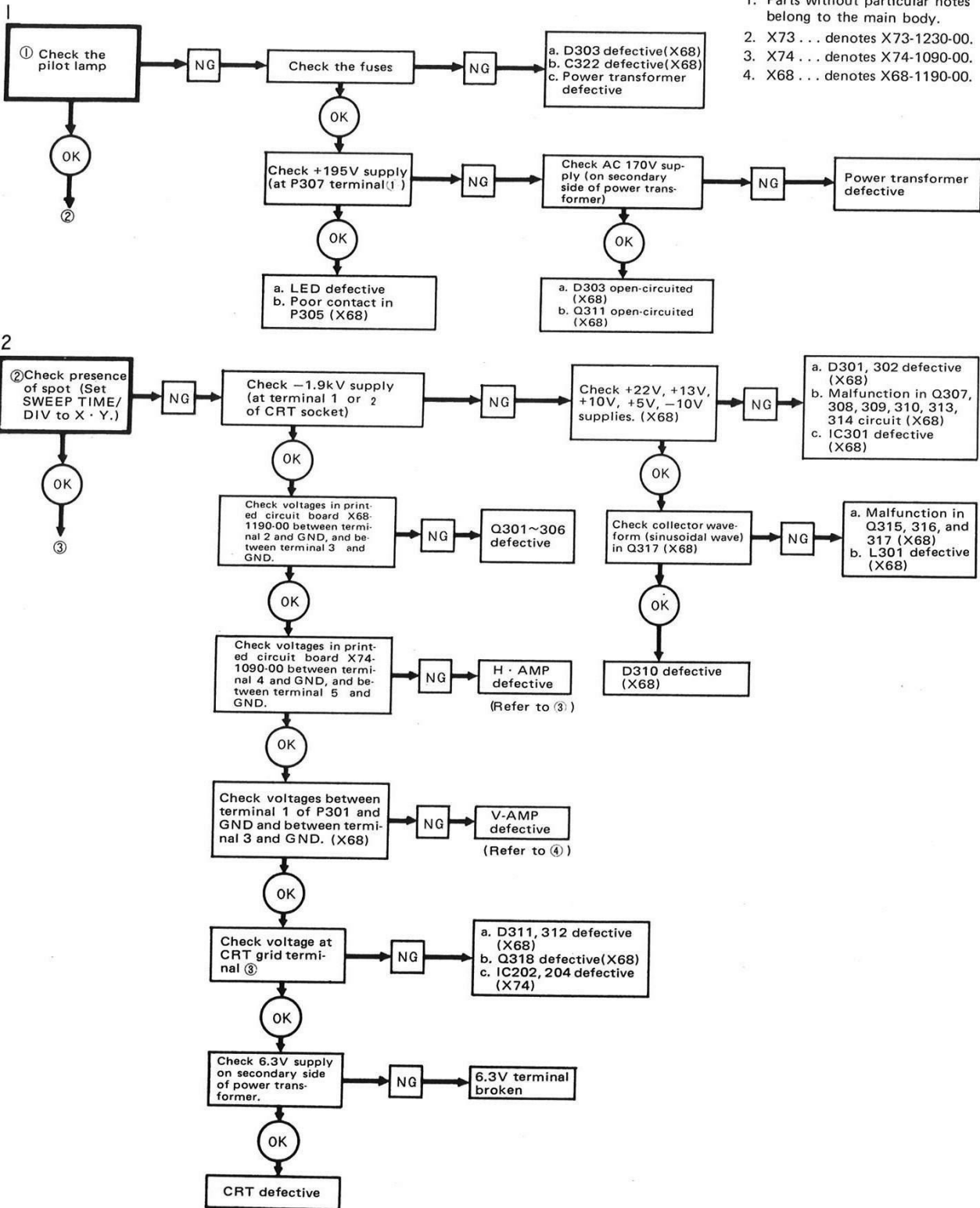

# TROUBLESHOOTING

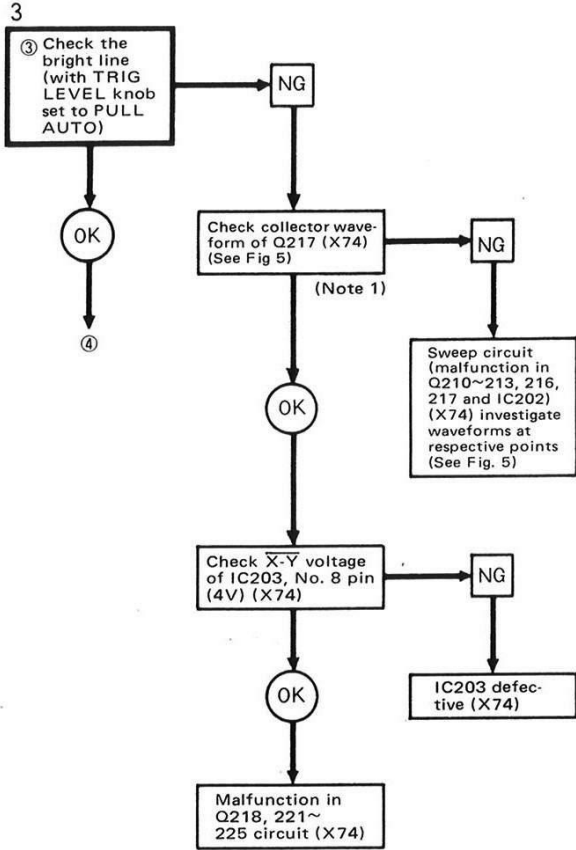
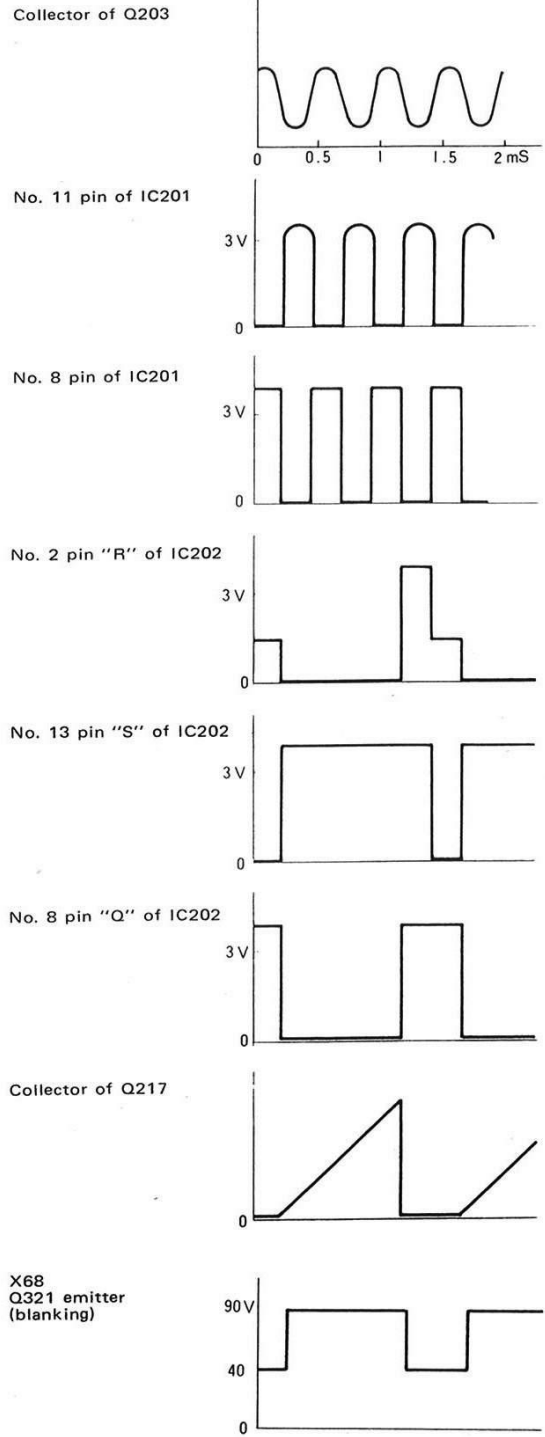

Fig. 5 Waveform in SWEEP Circuit  
(Input Signal 2 kHz Sine Wave)  
(SWEEP TIME 0.1mS/DIV)  
(X74-1090-00)



# TROUBLESHOOTING

Note: Add sine wave of 2 kHz to CH1 or CH2 vertical input terminal when checking items No. 4~9 (except No. 8).

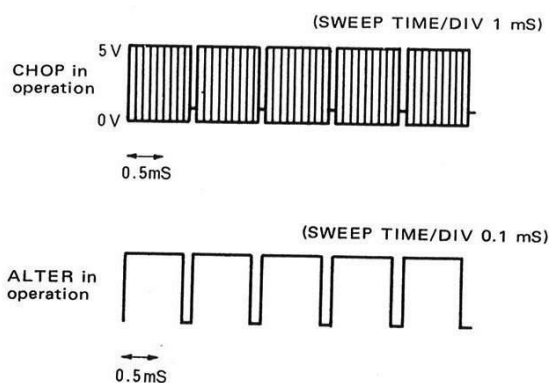
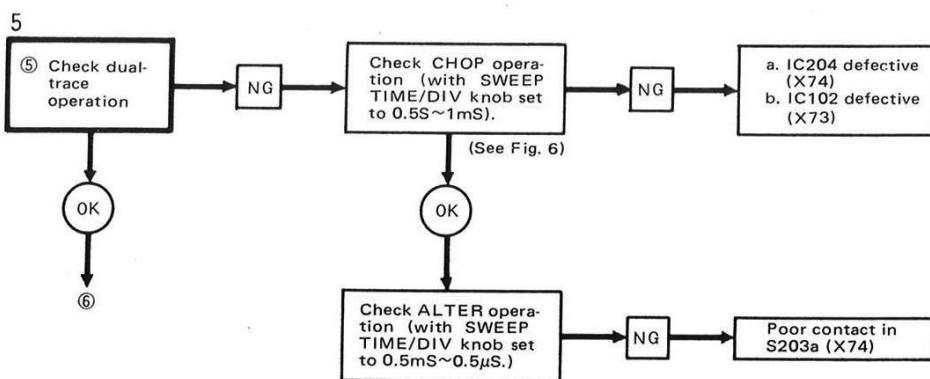
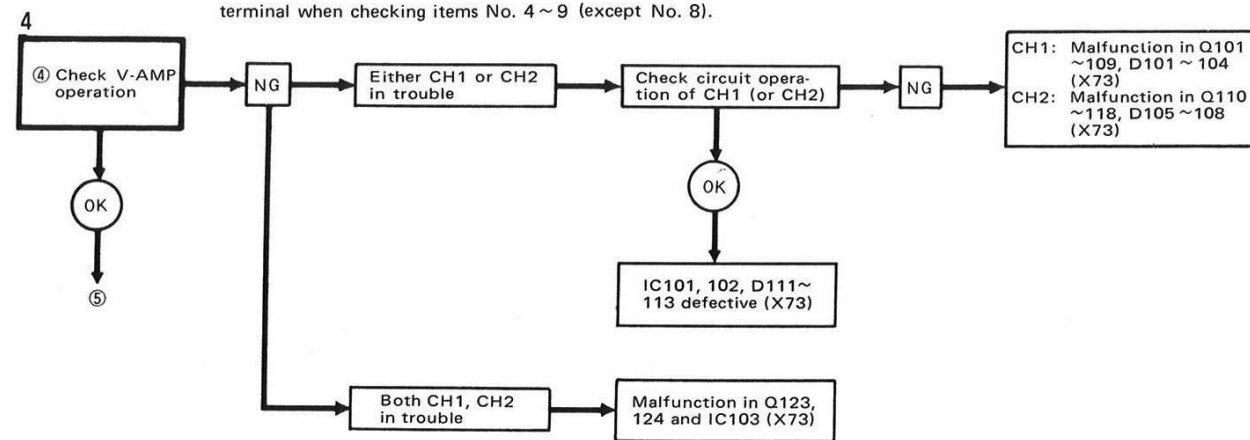
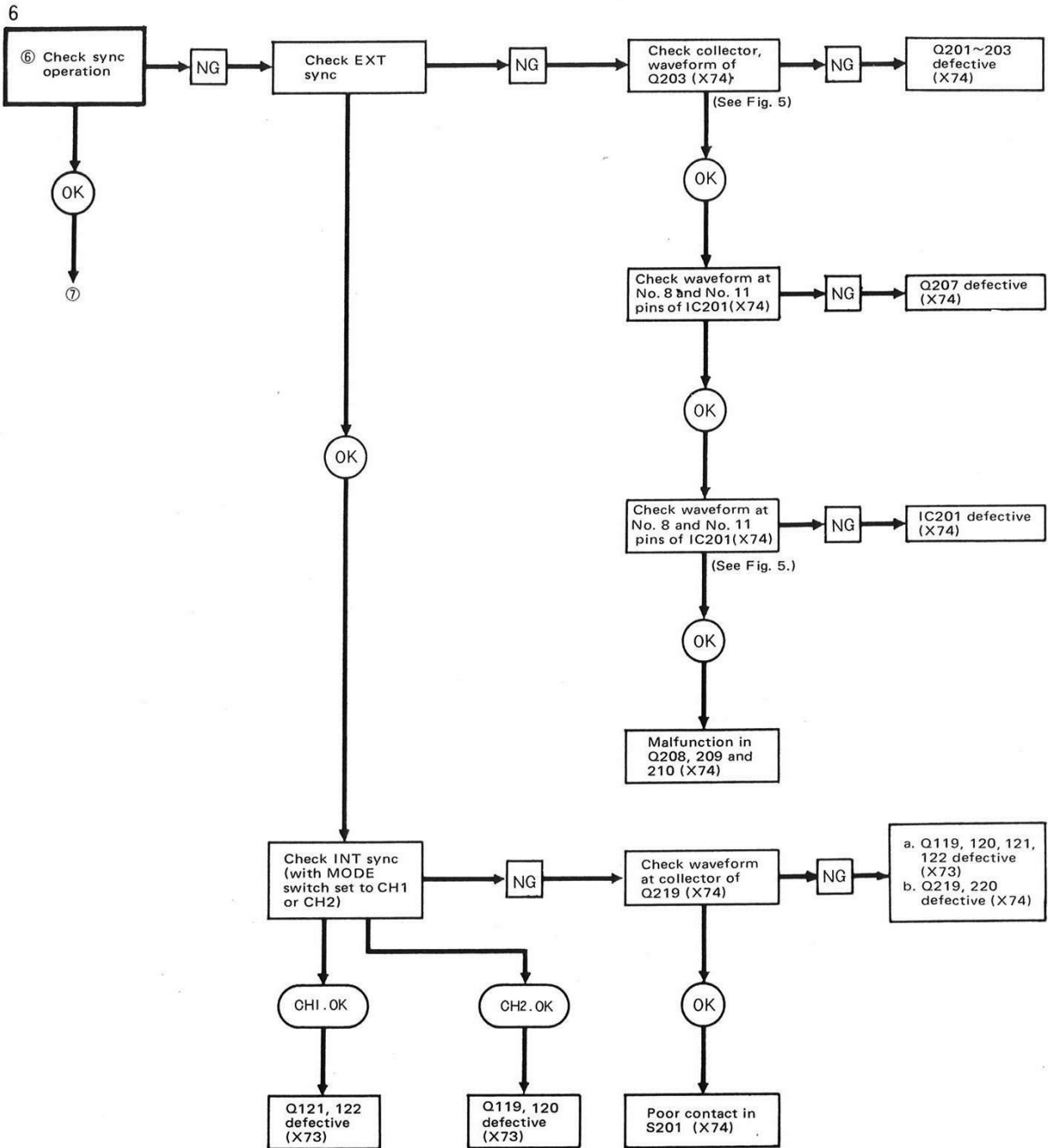
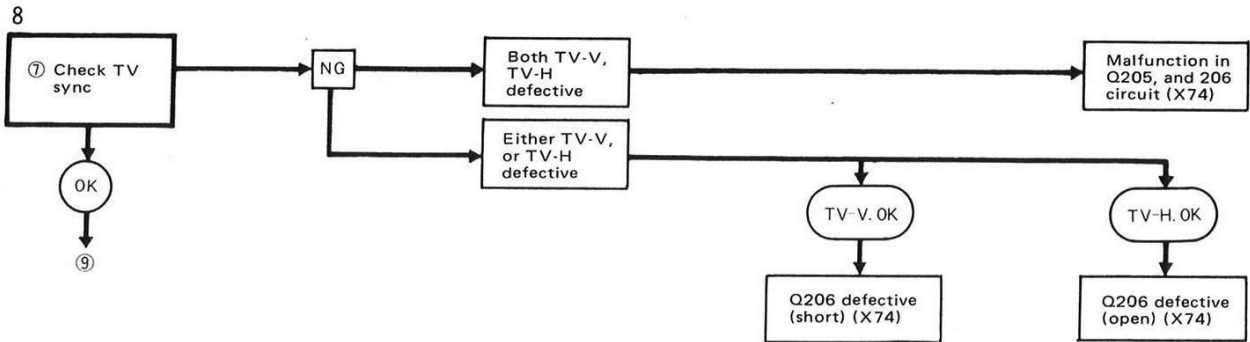
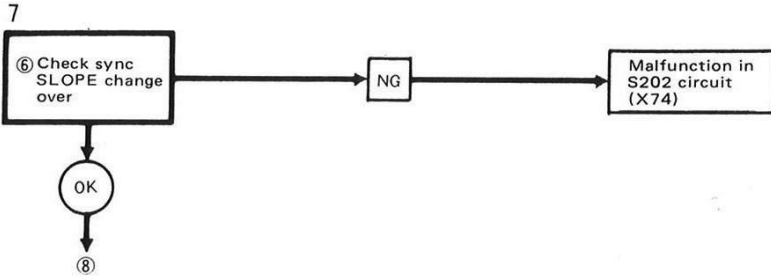

Fig. 6 C, P Waveforms at No. 1 Pin of P102 (X73)

# TROUBLESHOOTING



# TROUBLESHOOTING



Note:  
Add image signal from TV set to vertical input terminal.

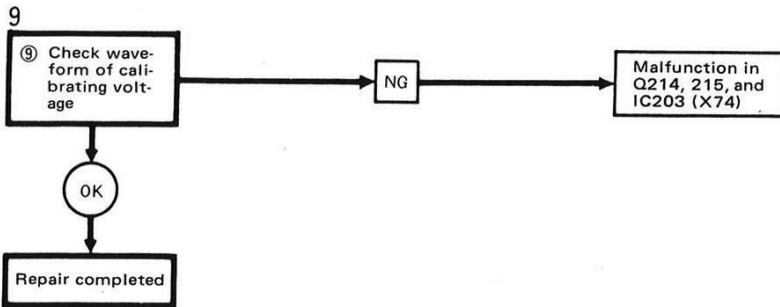
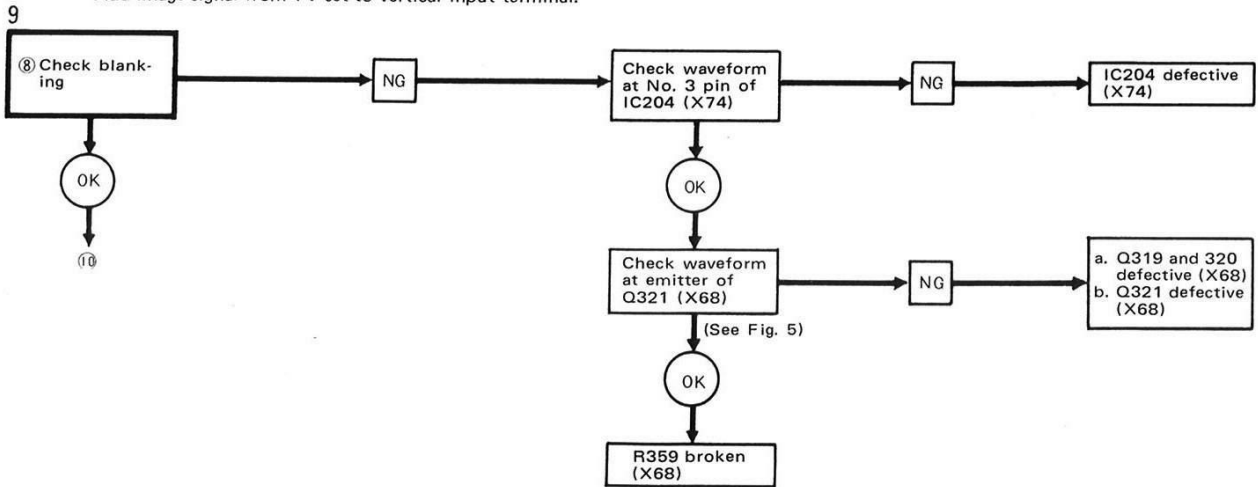

## ADJUSTMENTS

Observe the following before making adjustments:

1. The items given below are pre-adjusted at the factory before shipment. Should re-adjustment be required, it should be performed after calibrating the power source voltage (no adjustment is required on the probe).
2. All adjustments should be made with the semi-fixed resistors or the trimmers mounted on the printed circuit board. For adjustment, use a well-insulated flat-blade screwdriver.
3. A high voltage (about 2000V) is present on the lower circuit board. Be sure to turn the power off before removing the bottom cover.
4. For optimum adjustment, turn the power on and warm up the oscilloscope sufficiently before starting.

### DC BAL ADJUSTMENT

1. Set the CH1 input selector switch (DC-GND-AC) to GND.
2. Turn the vertical attenuator (VARIABLE) fully counterclockwise.
3. Turn the knob  $\blacktriangle$  (POSITION) to make the bright line coincide with the scale center.
4. As the vertical attenuator (VARIABLE) is turned fully counterclockwise, the bright line begins to move. Adjust CH1 DC BAL so that the bright line can coincide with the center.

5. Repeat the above adjustment until the bright line settles even when VARIABLE is turned.
6. Follow the same adjustment for CH2, using CH2 DC BAL.

### VERTICAL ATTENUATOR ADJUSTMENT (VOLTS/DIV)

1. Take out the interior from the case according to the procedures described for REMOVING THE CASE.
2. Connect a 1 kHz (output: 50 mV to 100 V p-p) square wave signal generator to the vertical input terminal.
3. With VOLTS/DIV set to 0.1V, adjust the trimmer TC101 (TC107 for CH2) on the lower printed circuit board until optimum square wave is obtained.
4. Successively change the range to 1V and 10V, and adjust the trimmers TC103 and TC105 (TC104 and TC111 for CH2) in the same manner.

### PROBE AND INPUT CAPACITANCE ADJUSTMENT

1. Set VOLTS/DIV to 0.01V.
2. Set the probe to 10 : 1 and connect it to the vertical INPUT terminal. Apply a 1 kHz square wave signal to the probe and adjust its trimmer for the optimum square waveform. In this case, input voltage is attenuated to 1/10, but input resistance and input capacitance

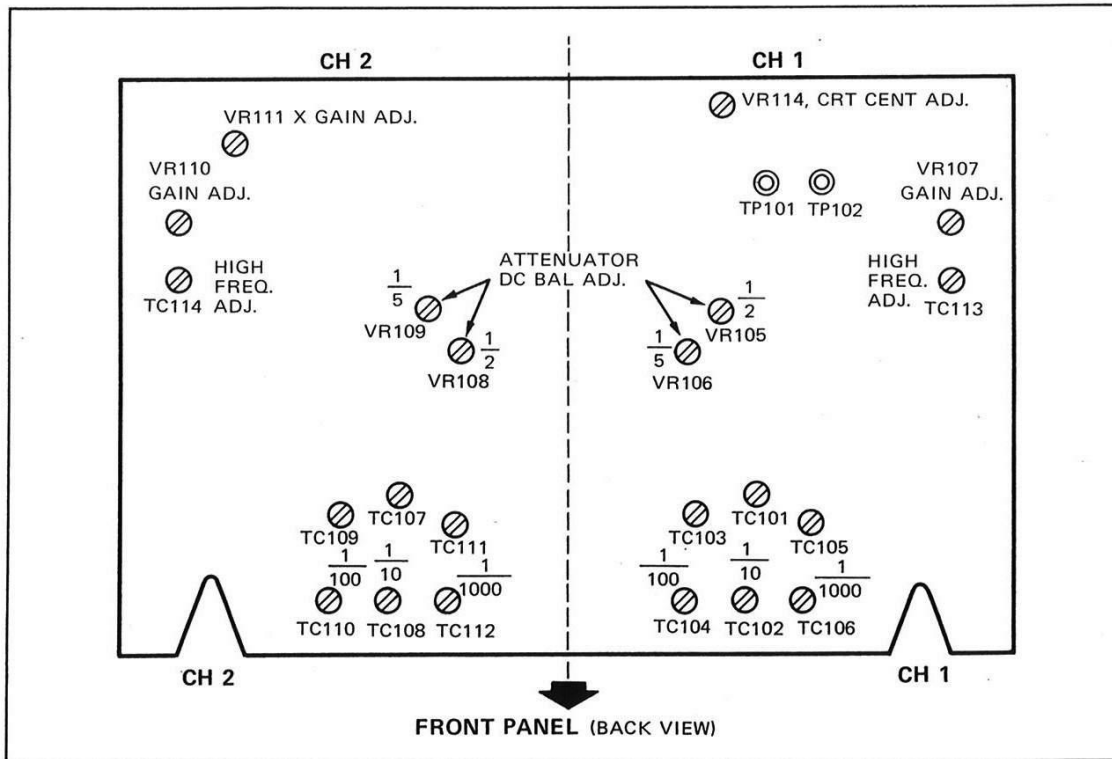

Fig. 7 Lower Printed Circuit Board (X73-1230-00)

## ADJUSTMENTS

- are reduced respectively to less than  $10\text{ M}\Omega$  and  $18\text{ pF}$ .
3. Set VOLTS/DIV to  $0.1\text{ V}$  and adjust the trimmer TC 102 (TC108 for CH2) on the lower printed circuit board so that optimum square wave can be obtained.
  4. Adjust the trimmers TC104 and TC106 (TC110 and TC112 for CH2) in the  $1\text{ V}$  and  $10\text{ V}$  ranges in the same manner.

### VERTICAL SENSITIVITY ADJUSTMENT

1. Remove the case according to the procedures described for REMOVING THE CASE.
2. Set VOLTS/DIV to  $0.01\text{ V}$  and turn VARIABLE fully clockwise to CAL.
3. Apply  $0.05\text{ V}$  p-p square wave signal to the vertical input.
4. Adjust VR107 GAIN ADJ (VR110 GAIN ADJ for CH2) on the lower printed circuit board to obtain 5 div of vertical amplitude.

### CRT CENTERING ADJUSTMENT

1. Short the test terminals TP101 and TP102 on the lower printed circuit board.
2. With a horizontal bright line displayed in CRT, adjust VR114 on the same printed circuit board until the bright line is centered.

### FREQUENCY CHARACTERISTICS AND OVERSHOOT ADJUSTMENT

1. Apply a  $100\text{ kHz}$  square wave signal having a good rise characteristic to the input.
2. Adjust the middle range of the square wave (after rising) with TC301 on the rear printed circuit board.
3. Adjust the high range of the square wave (rising portion) with VR305 on the same printed circuit board.
4. Adjust the high range for each channel; for CH1 with TC113 on the lower printed circuit board, and for CH2 with TC114.

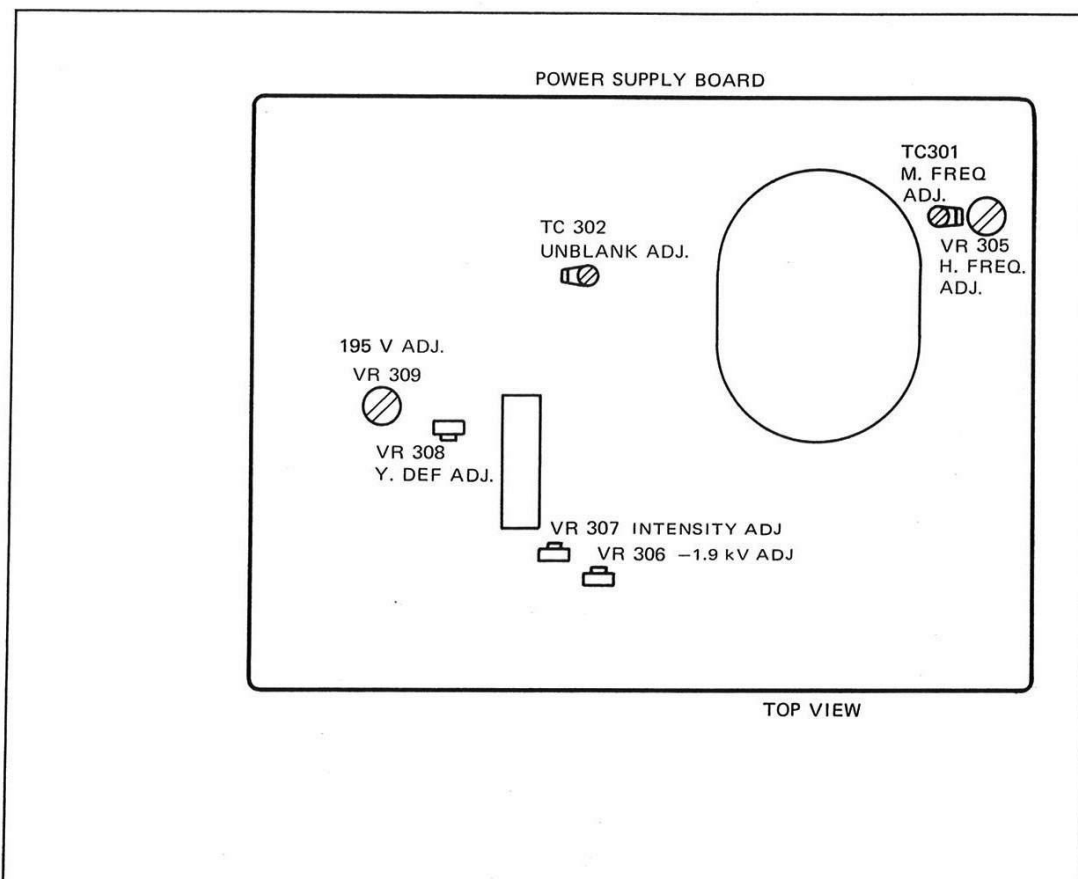

Fig. 8 Rear Printed Circuit Board (X68-1190-00)



## ADJUSTMENTS

### SWEEP TIME (HORIZONTAL SENSITIVITY) AND BRIGHT LINE LENGTH ADJUSTMENT

1. Remove the case according to the procedures described for REMOVING THE CASE.
2. Set SWEEP TIME/DIV to 0.1ms and turn VARIABLE fully clockwise to CAL.
3. Apply a 1 kHz frequency-calibrated sinusoidal wave signal to the input and adjust each POSITION so that the waveform is centered vertically and its starting point is positioned to the extreme left of the scale.
4. Adjust VR207 (TIME ADJ) on the side circuit board within the case so that 1 wave length of the 1 kHz sinusoidal wave corresponds to 10 div on the scale. At that time, length of the horizontal bright line will also vary. Adjust it with VR204 (LENGTH ADJ) on the same printed circuit board. Since the VR204 adjustment merely varies the end position of the waveform, length of the bright line can be adjusted without affecting the starting point and the sweep time. During this adjustment, manipulate ◀▶ POSITION and TRIG LEVEL in order to hold the starting point always in the center of the extreme left of the scale.
5. The above adjustment applies to the ranges of 0.1s to 0.1ms. For the ranges of 50 $\mu$ s to 0.5 $\mu$ s, the variable resistors VR204 and VR207 should not be moved on the printed circuit board. Instead, trimmers TC201 and TC202 (side printed circuit board) should be adjusted for the ranges of 10 $\mu$ s and 0.5 $\mu$ s as shown in Table 1.

Table 1

SWEEP TIME/DIV	Input frequency	Trimmers on side printed circuit board
10 $\mu$ s	10 kHz	TC 201
0.5 $\mu$ s	200 kHz	TC 202

### X 5 MAG ADJUSTMENT

1. Set SWEEP TIME/DIV switch to 1ms and apply a 1 kHz sinusoidal wave signal to the vertical input.
2. Adjust the oscillator frequency and ◀▶ POSITION to obtain 11 peaks of the waveform. Each peak should be on the vertical line on the scale.
3. With MAG switch pulled toward you, adjust VR209 (MAG ADJ) on the side printed circuit board so that the span between peaks is 5 div.

### MAG CENTER ADJUSTMENT

1. Set SWEEP TIME/DIV to 0.1ms and apply a 1 kHz square wave signal to the input until 1 wave length is spread over the entire scale.
2. Set ◀▶ POSITION to its mechanical center position. (Waveform may deviate in the horizontal direction.)
3. With MAG switch pulled toward you, adjust VR208 (MAG CENT) on the side printed circuit board until the rising (or falling) portion in the center of the waveform comes to the point obtained at "X1" (MAG switch depressed).

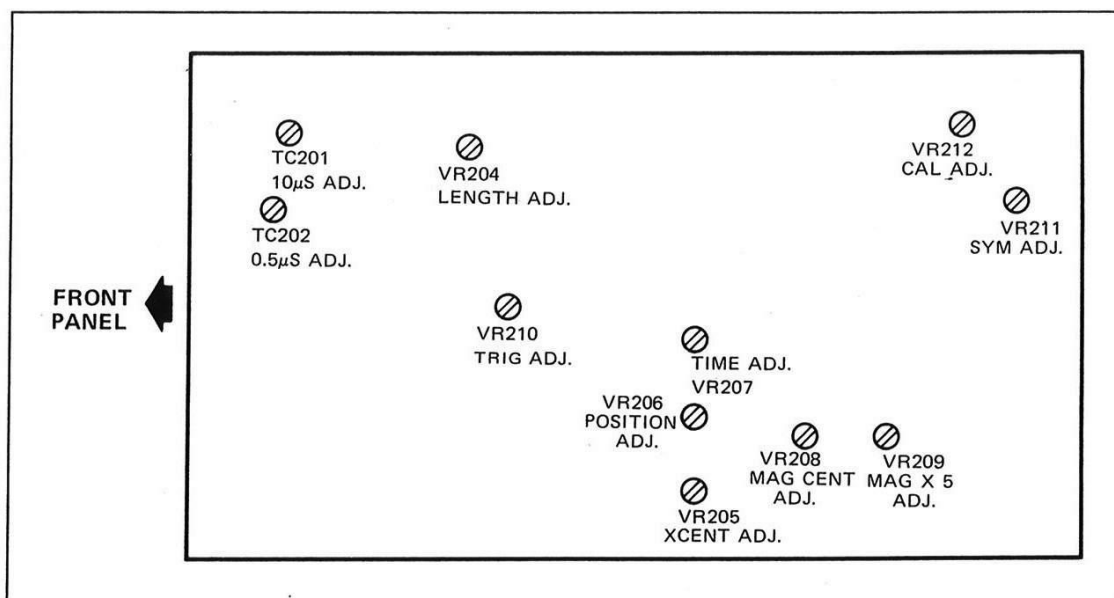

Fig. 9 Side Printed Circuit Board (X74-1090-00)

## ADJUSTMENTS

- Repeat this adjustment until the position of the rising (or falling) portion in the center of the waveform is not deflected regardless of the position of the MAG switch.
- Adjust VR206 (POS ADJ) on the side printed circuit board until the starting point of the waveform comes to the extreme left of the scale.

### HORIZONTAL POSITION ADJUSTMENT

- To adjust the horizontal position during ordinary sweep time, set  $\blacktriangleleft$  POSITION to its mechanical center position and adjust VR206 (POS ADJ) on the side printed circuit board until the starting point of the waveform comes to the extreme left of the scale.
- When SWEEP TIME/DIV is in X-Y setting, adjust VR 205 on the same printed circuit board after the above adjustment until the spot comes to the center of the scale.

### SYNCHRONIZING LEVEL ADJUSTMENT

- Apply a 1 kHz sinusoidal wave signal to the input. Set SYNC switch to NORM.
- Adjust VR210 (TRIG ADJ) on the side printed circuit board so that the waveform can be started in the same position on the reverse slope when SLOPE is switched between + and -.

### CALIBRATING VOLTAGE ADJUSTMENT

Adjust VR212 on the side printed circuit board so that 1V p-p of 1 kHz square wave calibrating output voltage can be obtained.

### ASTIG ADJUSTMENT

Adjust ASTIG on the front panel to unify thickness of the waveform bright line. This adjustment is made together with FOCUS.

### HIGH VOLTAGE ADJUSTMENT

- Connect a DC voltmeter having high input impedance (more than 100 M $\Omega$ ) to CRT's socket terminal 1, 7, or 14.
- Adjust VR306 on the rear printed circuit board for a reading of -1.9 kV on the voltmeter.

### BLANKING VOLTAGE ADJUSTMENT

- By pulling PULL AUTO, display a bright line on the CRT screen.
- Adjust VR307 on the rear printed circuit board so that the bright line disappears in 9 ~ 11 o'clock position of the brightness control knob.

### 195V ADJ ADJUSTMENT

Adjust VR309 on the rear printed circuit board until voltage of No. 1 pin of the connector P307 on the rear printed circuit board attains 195 volts.

### VERTICAL DYNAMIC RANGE ADJUSTMENT

- Use a measuring circuit shown in Fig.10.
- Connect the two lead wires with the terminals 10 and 12 (vertical deflection terminal) of the CRT socket.
- Set the input to GND and display the bright line in the center of the scale.
- Adjust VR308 on the rear printed circuit board until the DC voltmeter indicates 85 volts.

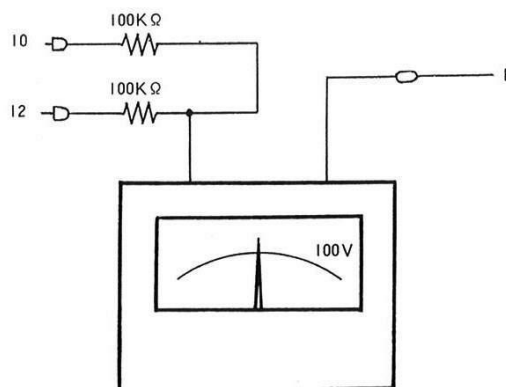
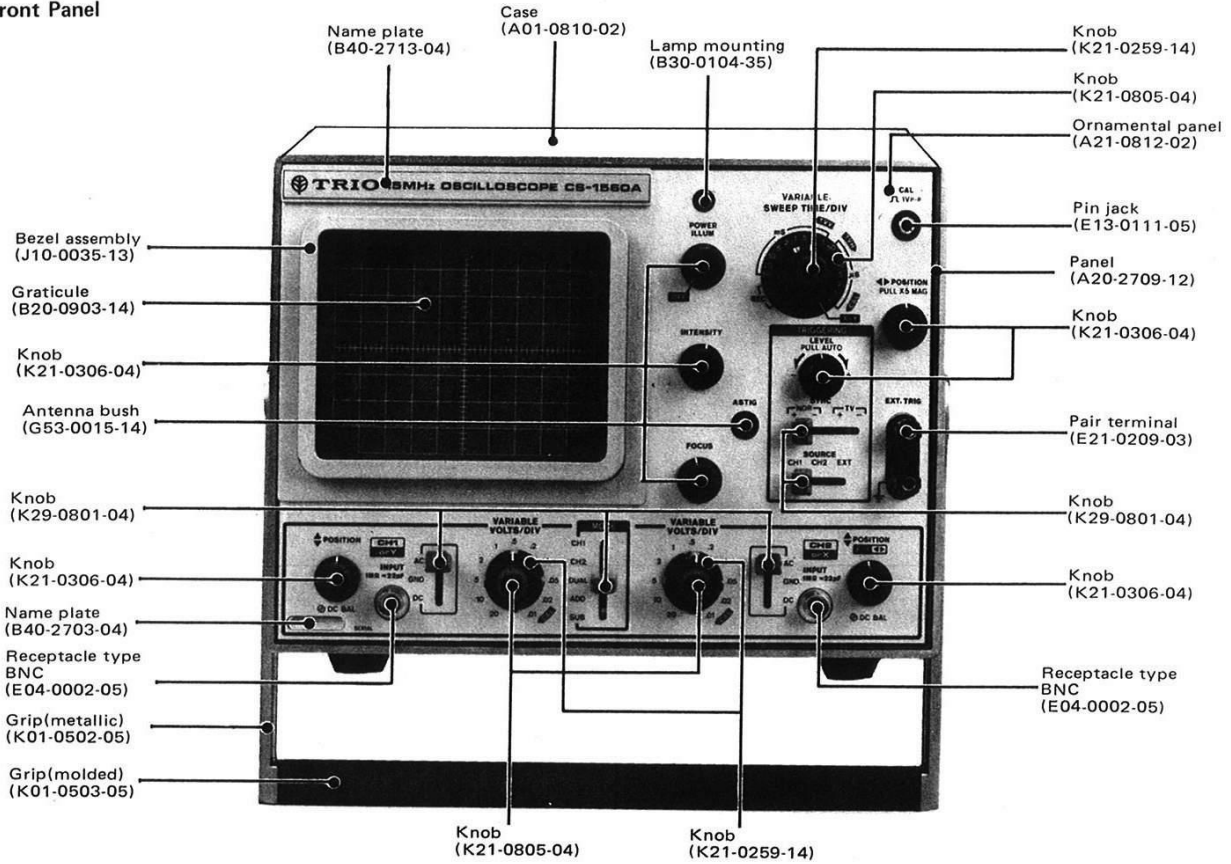

Fig. 10

# PARTS ALIGNMENT

## Front Panel



## Rear Panel

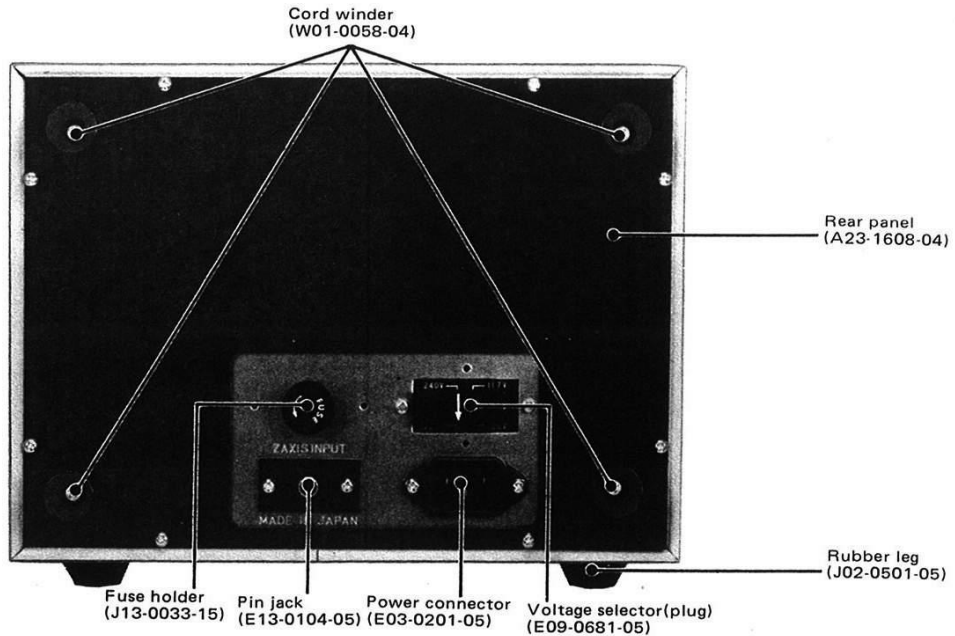

# PARTS ALIGNMENT

Panel (Right Side)

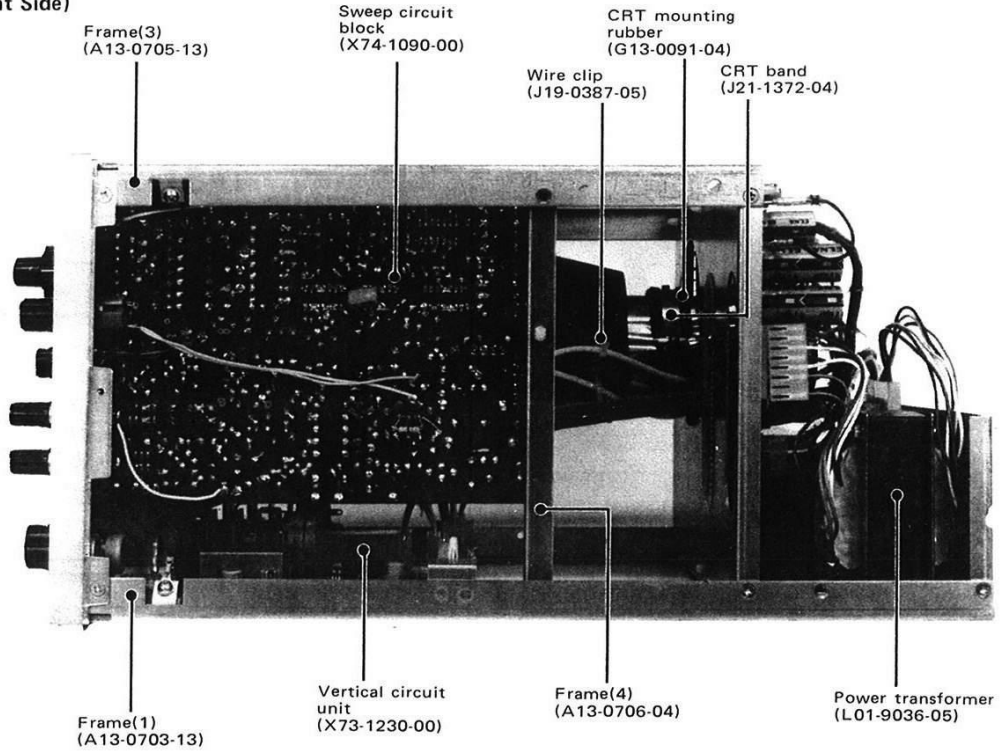

Panel (Left Side)

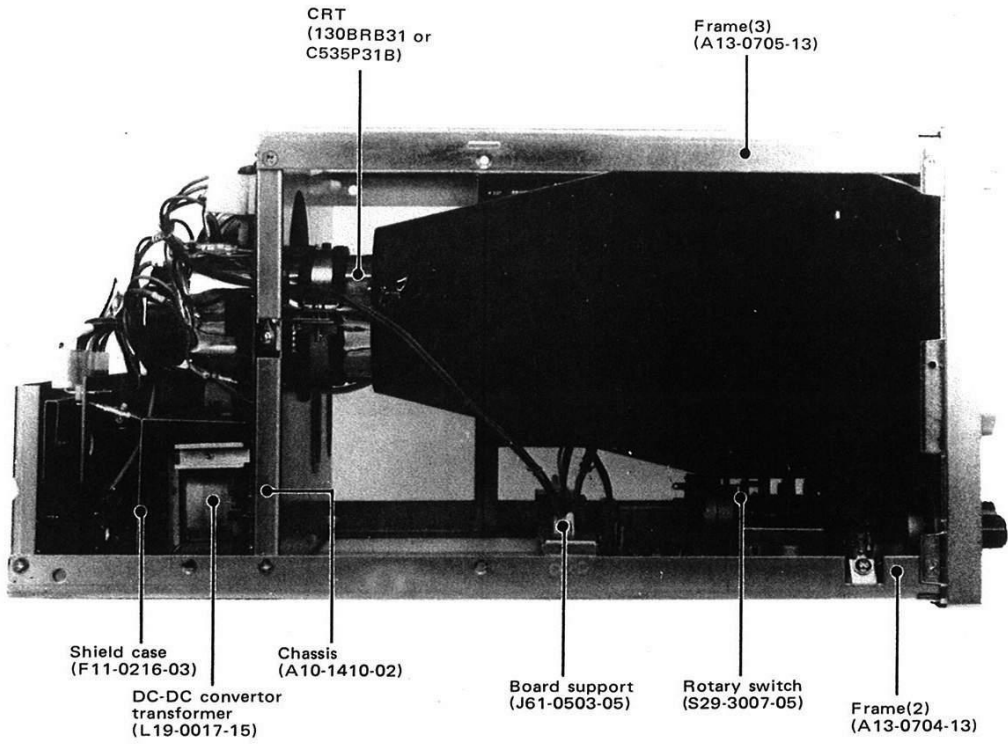

# PARTS ALIGNMENT

Chassis (Upper)

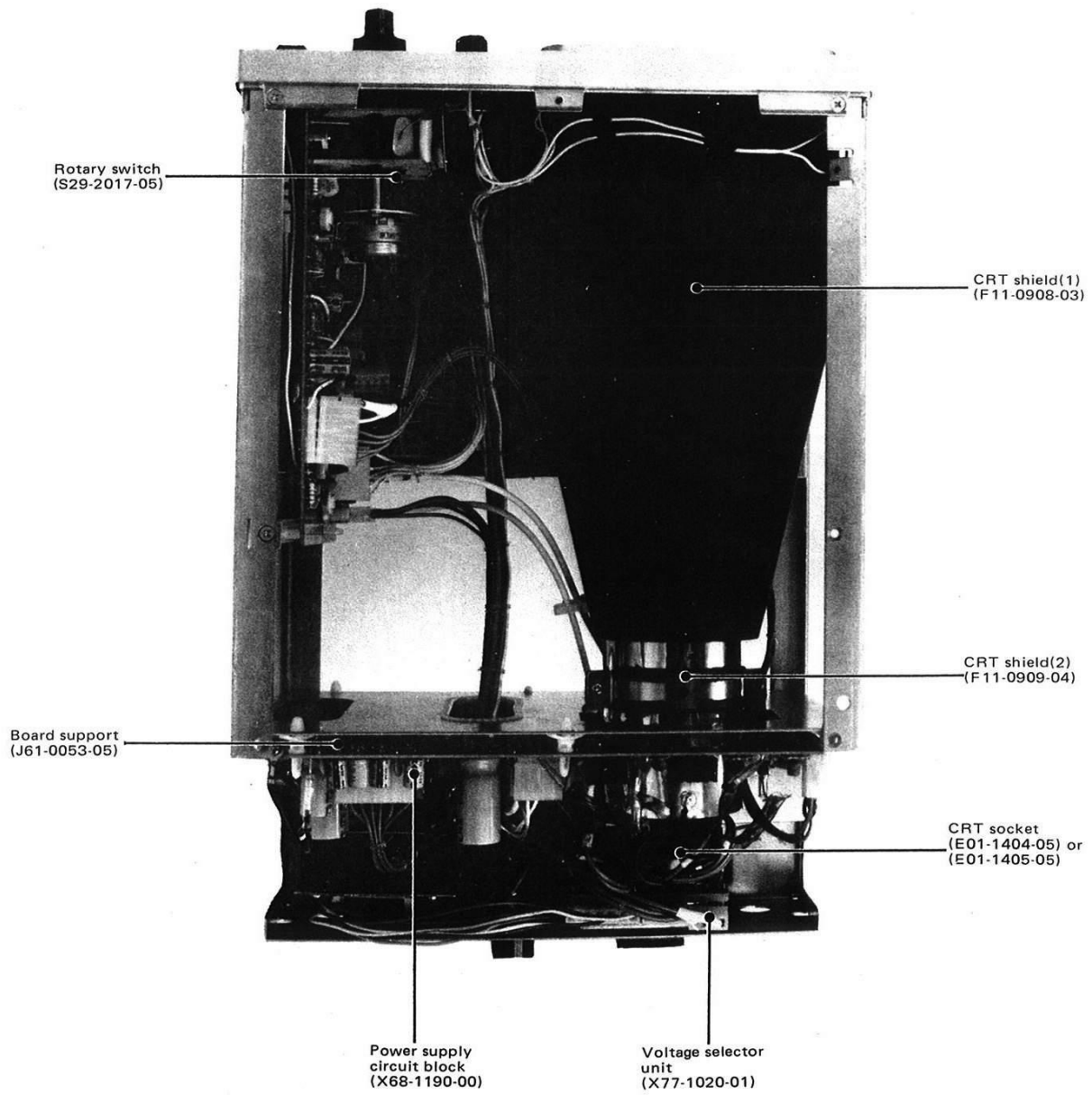

# PC BOARD

(X68-1190-00)

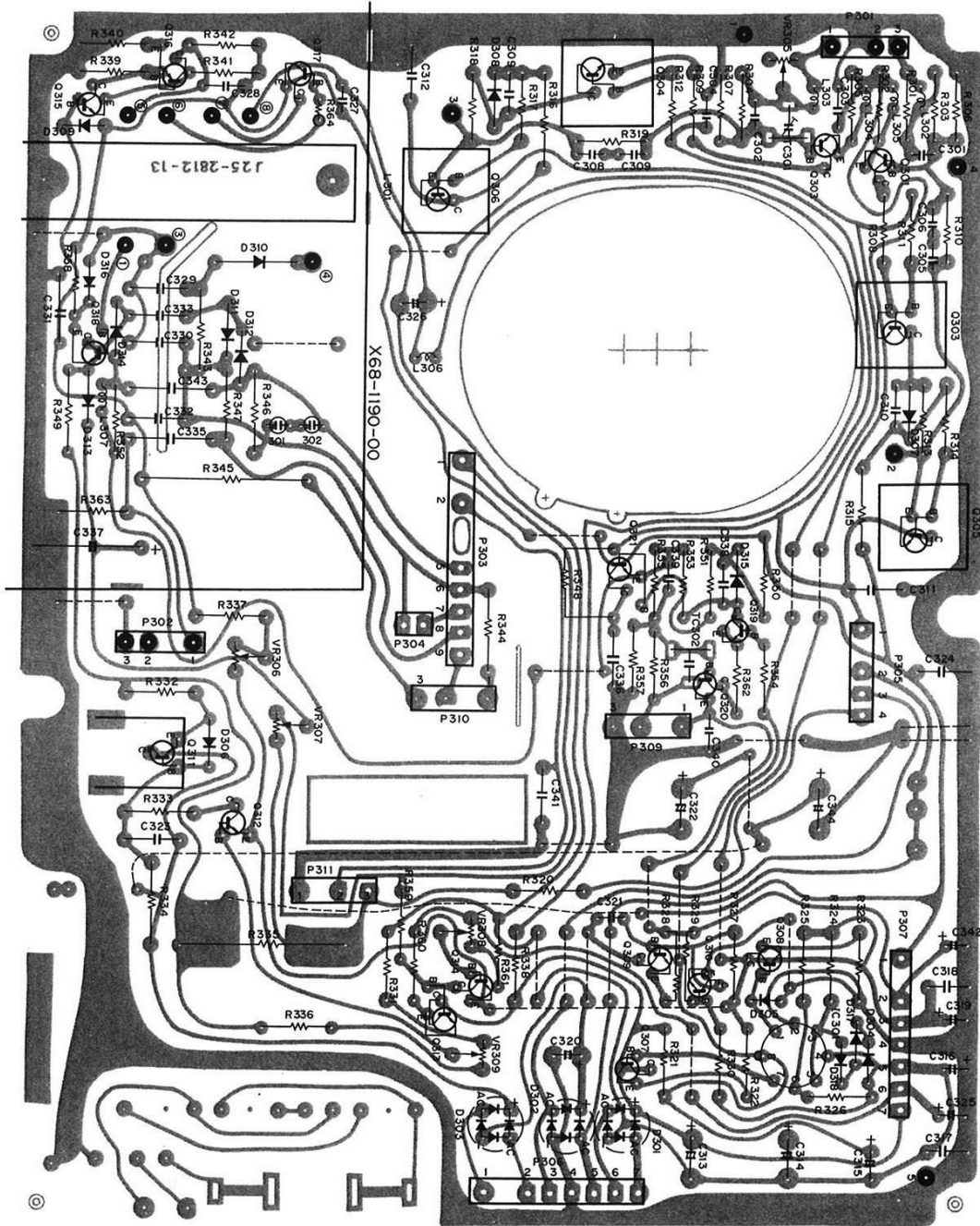

Q301, 302, 310, 313~315, 320:2SC458-C, Q303~306:2SC154-C, Q307~309:2SC1419-C, Q311, 312:2SC1507, Q316:2SA733 (O or R), Q317: 2SD401, Q318, 319, 321:2SC983-Y, IC301: RC4558, D301~303:W04M, D304: WZ090, D305, 306, 309, 316~318: 1S1555, D307, 308, 315:WZ050, D310:Y16JA, D311~313:V06E, D314:1S1705

# PC BOARD

(X73-1230-00)

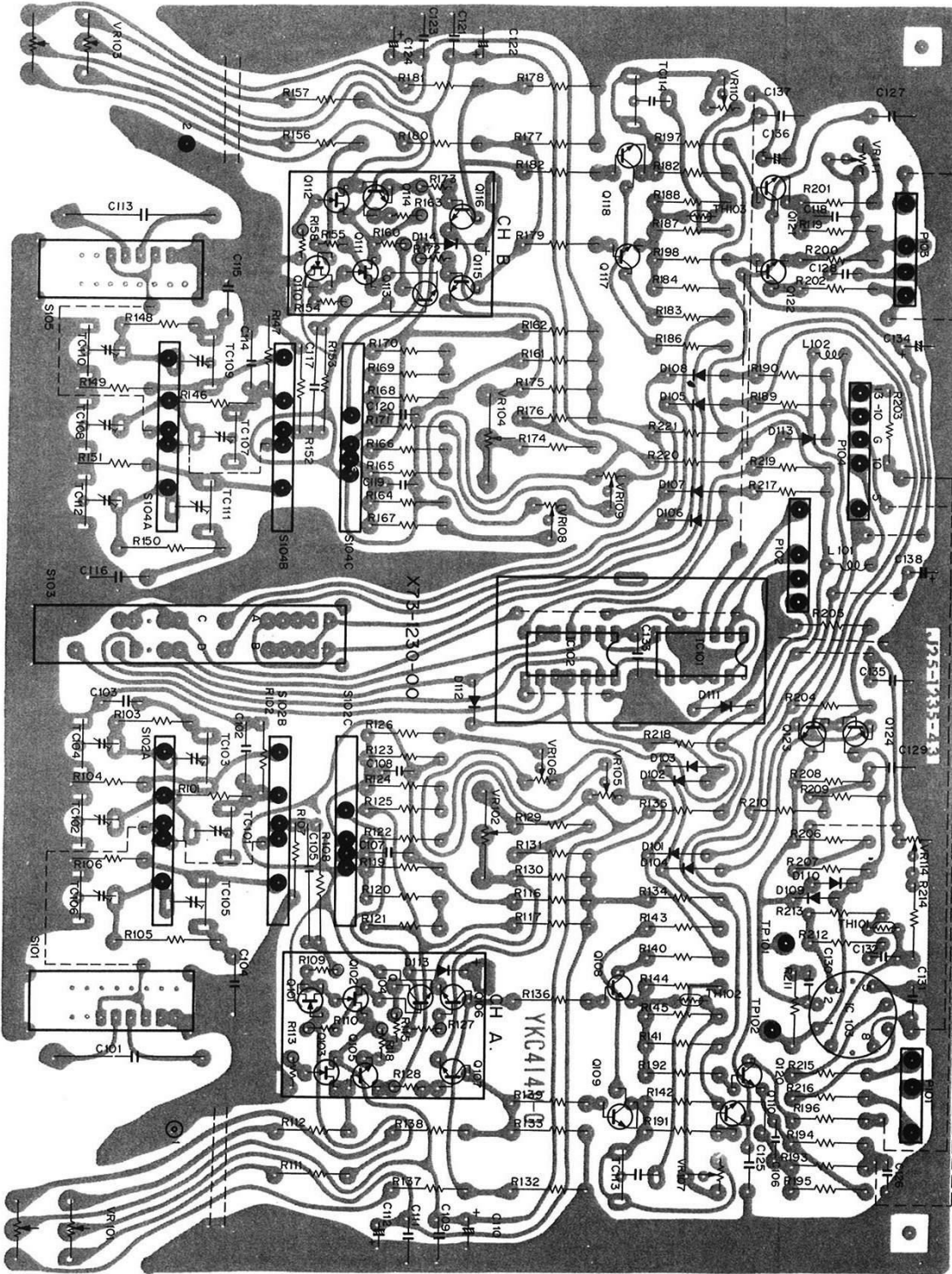

Q101~103, 110~112: 2SK30A-O, Q104~109, 113~124: 2SC535-B, IC101:TD-3472AP, IC102:TD-3403AP, IC103: RC733T,  
D101~108, 111~117: 1S1555, D109, 110: 1S1587, TH101: SDT-1000

# PC BOARD

(X74-1090-00)

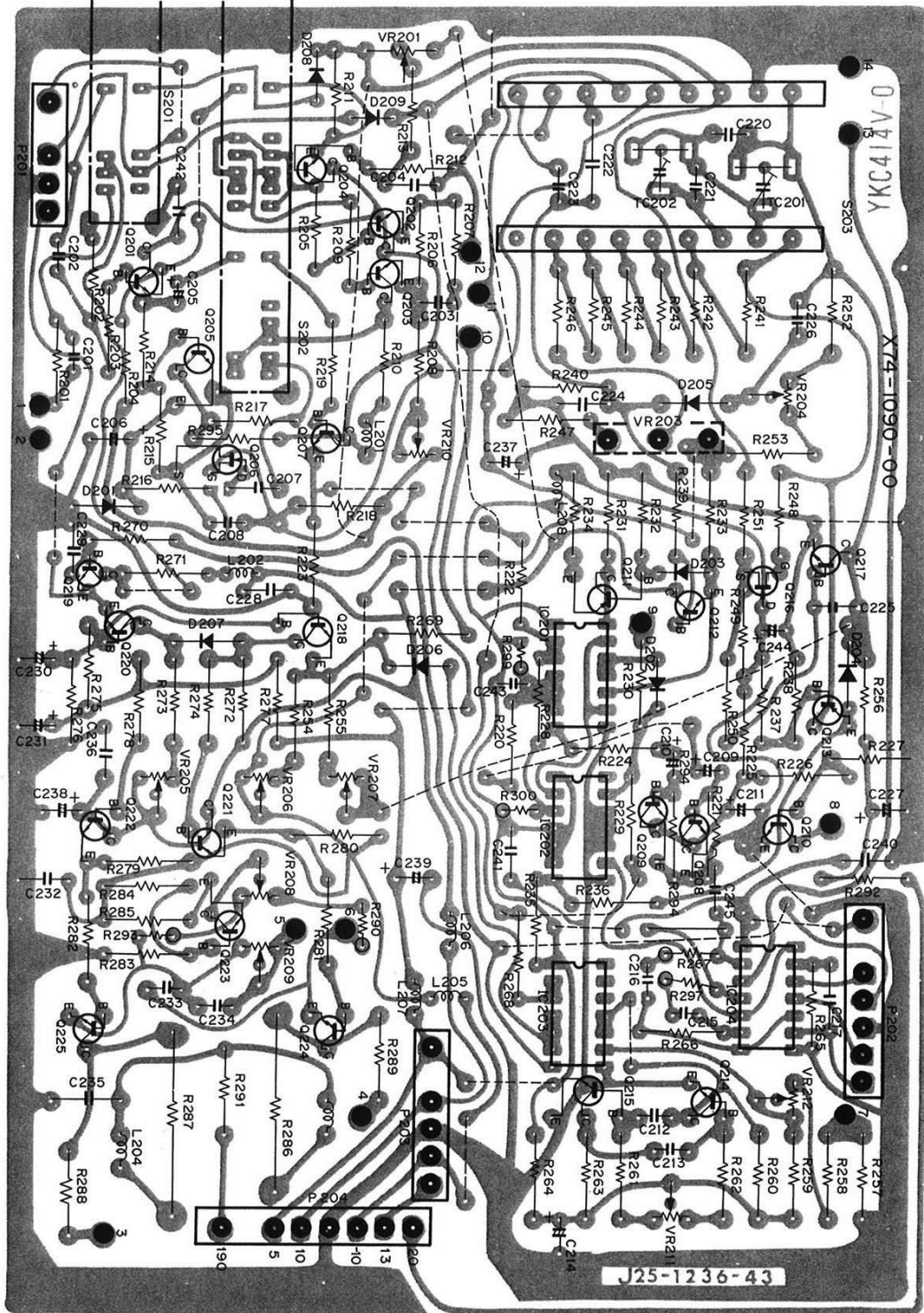

Q201, 204, 205, 207~210, 212, 214, 215, 217~223: 2SC458-C, Q202, 203:2SC535-B, Q206, 216:2SK30A (GR), Q211, 213:2SA733 (Q or R),  
Q224, 225: 2SC1507, IC201, 203, 204:TD-3400AP, IC202:TD-3472AP, D201~209:1S1555



# PARTS LIST

## TOTAL

Ref. No.	Parts No.	Description	Ref. No.	Parts No.	Description
VR1,S1	R03-0001-15	Variable resistor 100Ω w/SW	—	J42-0502-04	Lamp mounting rubber
VR2	R01-0039-05	Variable resistor 500Ω (B)	—	J61-0039-05	Wire clip
VR3	R05-8001-05	Variable resistor 3MΩ	—	J61-0049-05	Cable wrapping-band
VR4	R01-6003-05	Variable resistor 250kΩ (B)	—	J61-0053-05	Board support
—	A01-0810-02	Case	—	J61-0503-05	Board support
—	A10-1410-02	Chassis	—	K01-0501-05	Grip ass'y
—	A13-0703-13	Frame (1)	—	K01-0502-05	Grip
—	A13-0704-13	Frame (2)	—	K01-0503-05	Grip
—	A13-0705-13	Frame (3)	—	K21-0259-14	Knob 22.8φ
—	A13-0706-04	Frame (4)	—	K21-0306-04	Knob 17φ
—	A20-2709-12	Panel	—	K21-0804-04	Knob 17φ
—	A21-0812-02	Ornamental panel	—	K21-0805-04	Knob (blue) 13φ
—	A23-1608-04	Rear panel	—	K29-0801-04	Knob (green) for leverswitch
—	B19-0701-14	Filter	—	L01-9036-05	Power trans transformer
—	B20-0903-14	Graticule	—	130BRB31 or	CRT tube
—	B30-0104-35	Lamp mounting	—	C535P31B	
—	B40-2703-04	Name plate	—	W01-0058-04	Cord winder
—	B40-2713-04	Name plate (CS-1560A)	—	X68-1190-00	Power supply circuit block
—	B41-0701-04	Name plate of voltage	—	X73-1230-00	Vertical amplifier block
—	B50-2822-00	Instruction manual	—	X74-1090-00	Sweep circuit block
—	E01-1404-05 or	CRT socket	—	X77-1020-01	Voltage selector unit
—	E01-1405-05				
—	E03-0201-05	Power connector	—	Y87-1200-01	Probe (PC-27)
—	E13-0104-05	Pin jack			
—	E14-0101-05	Pin plug			
—	E14-0107-05	Pin plug (shorting)			
—	E30-1818-05	JIS cord			
—	E30-0481-35	Lead wire w/1P connector			
—	E30-0482-35	Lead wire w/1P connector			
J1	E30-0483-05	Lead wire w/3P connector			
J2	E31-0521-15	Lead wire with connector			
J3	E30-0486-05	Lead wire w/4P connector			
J4	E30-0487-05	Lead wire w/5P connector			
J5	E30-0488-25	Lead wire w/7P connector			
J6	E30-0484-05	Lead wire w/3P connector			
J7	E30-0489-15	Lead wire w/9P connector (for CRT socket)			
J8	E30-0554-15	Lead wire with connector			
J9	E31-0534-05	Lead wire with connector			
J10, 11	E31-0520-15	Lead wire with connector			
J13	E30-0556-15	Lead wire w/5P connector			
—	E31-0507-05	Lead wire with connector			
—	E31-0532-05	Lead wire with connector			
—	F05-3011-05	Fuse (0.3A)			
—	F05-7011-05	Fuse (0.7A)			
—	F11-0216-03	Shield case			
—	F11-0908-03	CRT shield (1)			
—	F11-0909-04	CRT shield (2)			
—	F15-0701-04	Felt 420 x 20 x 2t			
—	F20-0601-04	Insulation sheet			
—	G02-0601-04	Spring			
—	G13-0091-04	CRT mounting rubber			
—	G53-0601-04	Bezel bush			
—	H01-2810-04	Packing case			
—	H10-2801-03	Packing material, foamed styrene			
—	H20-1701-14	Protection cover			
—	H25-0029-04	Polyethylene bag			
—	J02-0501-05	Rubber leg			
—	J10-0026-12	Bezel			
—	J10-0035-13	Bezel ass'y			
—	J13-0033-15	Fuse holder			
—	J21-1372-04	CRT band			
—	J21-2805-05	Grip mounting hardware			
—	J21-2823-04	VR mounting hardware			
—	J42-0017-05	Rubber bush			

### POWER SUPPLY CIRCUIT BLOCK (X68-1190-00)

Ref. No.	Parts No.	Description
<b>CAPACITOR</b>		
C301	CC45CH1H120J	Ceramic 12pF ±5%
C302	CC45CH1H100D	Ceramic 10pF ±0.5pF
C303	C90-0298-05	Semiconductor ceramic 0.1μF +80%, -20%
C304	CK45D1H103M	Ceramic 0.01μF ±20%
C305~308	CC45CH2H010C	Ceramic 1pF ±0.25pF
C309, 310	C90-0298-05	Semiconductor ceramic 0.1μF +80%, -20%
C311, 312	CK45D2H103M	Ceramic 0.01μF ±20%
C313, 314	CE04W1H471	Electrolytic 470μF 50WV
C315	CE04W1H101	Electrolytic 100μF 50WV
C316	CE04W1C470	Electrolytic 47μF 16WV
C317, 318	C90-0298-05	Semiconductor ceramic 0.1μF +80%, -20%
C319	CE04W1C470	Electrolytic 47μF 16WV
C320	CE04W1A102	Electrolytic 1000μF 10WV
C321	CK45D1H103M	Ceramic 0.01μF ±20%
C322	CE04W2E470	Electrolytic 47μF 250WV
C323, 324	CK45D2H103M	Ceramic 0.01μF ±20%
C325	CE04W1C470	Electrolytic 47μF 16WV
C326	CE04W1H101	Electrolytic 100μF 50WV
C327	CK45D1H103M	Ceramic 0.01μF ±20%
C328	CQ93M1H153M	Mylar 0.015μF ±20%
C329, 330	CK45E3D472PMU	Ceramic 4700pF +100%, -0%
C331	CQ93M1H104M	Mylar 0.1μF ±20%
C332	CK45E3D102PMU	Ceramic 1000pF +100%, -0%
C333	CK45E3D472PMU	Ceramic 4700pF +100%, -0%
C334	—	—
C335	CK45E3D103PMU	Ceramic 0.01μF +100%, -0%
C336	CK45D2H103M	Ceramic 0.01μF ±20%
C337	CE02W2E010	Electrolytic 1μF 250WV
C338	C90-0298-05	Semiconductor ceramic 0.1μF +80%, -20%
C339	CC45CH2H010C	Ceramic 1pF ±0.25pF
C340	C90-0298-05	Semiconductor ceramic 0.1μF +80%, -20%

## PARTS LIST

Ref. No.	Parts No.	Description	Ref. No.	Parts No.	Description
C341	CK45D2H103M	Ceramic 0.01 $\mu$ F $\pm$ 20%	TC301	C05-0010-15	Ceramic trimmer 10pF
C342	CE04W1A101	Electrolytic 100 $\mu$ F 10WV	TC302	C05-0013-15	Ceramic trimmer 20pF
C343	CK45E3D103PMU	Ceramic 0.01 $\mu$ F +100%, -0%	<b>SEMICONDUCTOR</b>		
C344	CE04W2E470	Electrolytic 47 $\mu$ F 250WV	Q301, 302		Transistor 2SC458-C
<b>RESISTOR</b>			Q303~306		Transistor 2SC154-C
R301	RD14BY2E471J	Carbon 470 $\Omega$ $\pm$ 5% 1/4W	Q307~309		Transistor 2SC1419-C
R302	RD14BY2E220J	Carbon 22 $\Omega$ $\pm$ 5% 1/4W	Q310		Transistor 2SC458-C
R303, 304	RD14BY2E472J	Carbon 4.7k $\Omega$ $\pm$ 5% 1/4W	Q311, 312		Transistor 2SC1507
R305	RD14BY2E220J	Carbon 22 $\Omega$ $\pm$ 5% 1/4W	Q313~315		Transistor 2SC458-C
R306, 307	RD14BY2E223J	Carbon 22k $\Omega$ $\pm$ 5% 1/4W	Q316		Transistor 2SA733-Q or R
R308, 309	RD14BY2E100J	Carbon 10 $\Omega$ $\pm$ 5% 1/4W	Q317		Transistor 2SD401
R310	RD14BY2E104J	Carbon 100k $\Omega$ $\pm$ 5% 1/4W	Q318, 319		Transistor 2SC983-Y
R311, 312	RD14BY2E100J	Carbon 10 $\Omega$ $\pm$ 5% 1/4W	Q320		Transistor 2SC458-C
R313	RD14BY2E331J	Carbon 330 $\Omega$ $\pm$ 5% 1/4W	Q321		Transistor 2SC983-Y
R314	RD14BY2E470J	Carbon 47 $\Omega$ $\pm$ 5% 1/4W	IC301	IC	RC4558T
R315, 316	RD14BY2H473J	Carbon 47k $\Omega$ $\pm$ 5% 1/2W	D301~303		Bridge selector W04M
R317	RD14BY2E470J	Carbon 47 $\Omega$ $\pm$ 5% 1/4W	D304		Zener diode WZ090
R318	RD14BY2E331J	Carbon 330 $\Omega$ $\pm$ 5% 1/4W	D305, 306		Diode 1S1555
R319	RD14BY2E104J	Carbon 100k $\Omega$ $\pm$ 5% 1/4W	D307, 308		Zener diode WZ050
R320	RD14BY2E470J	Carbon 47 $\Omega$ $\pm$ 5% 1/4W	D309		Diode 1S1555
R321	RD14BY2E331J	Carbon 330 $\Omega$ $\pm$ 5% 1/4W	D310		Diode Y16JA
R322	RD14BY2E220J	Carbon 22 $\Omega$ $\pm$ 5% 1/4W	D311~313		Diode V06E
R323	RD14BY2E470J	Carbon 47 $\Omega$ $\pm$ 5% 1/4W	D314		Diode 1S1705
R324	RD14BY2E472J	Carbon 4.7k $\Omega$ $\pm$ 5% 1/4W	D315		Zener diode WZ050
R325, 326	RS14BK2E1002F	Metal film 10k $\Omega$ $\pm$ 1% 1/4W	D316~318		Diode 1S1555
R327	RD14BY2E152J	Carbon 1.5k $\Omega$ $\pm$ 5% 1/4W	<b>COIL</b>		
R328	RD14BY2E2R2J	Carbon 2.2 $\Omega$ $\pm$ 5% 1/4W	L301	L19-0017-05	DC-DC convertor transformer EI-40
R329	RD14BY2E332J	Carbon 3.3k $\Omega$ $\pm$ 5% 1/4W	L302, 303	L40-6801-03	Ferri-inductor 68 $\mu$ H
R330	RD14BY2E822J	Carbon 8.2k $\Omega$ $\pm$ 5% 1/4W	L304, 305	L40-3392-02	Ferri-inductor 3.3 $\mu$ H
R331	RD14BY2E223J	Carbon 22k $\Omega$ $\pm$ 5% 1/4W	L306	L40-3311-03	Ferri-inductor 330 $\mu$ H
R332	RD14BY2E470J	Carbon 47 $\Omega$ $\pm$ 5% 1/4W	L307	L40-4791-02	Ferri-inductor 4.7 $\mu$ H
R333	RD14BY2E322J	Carbon 2.2k $\Omega$ $\pm$ 5% 1/4W	<b>MISCELLANEOUS</b>		
R334	RD14BY2H103J	Carbon 10k $\Omega$ $\pm$ 5% 1/2W	N301, 302		Neon lamp NE-2
R335	RS14GB3F152J	Metal film 1.5k $\Omega$ $\pm$ 5% 3W	P301, 302	E40-0303-05	Pin connector 3P
R336	RD14BY2E224J	Carbon 220k $\Omega$ $\pm$ 5% 1/4W	P303	E40-0903-05	Pin connector 9P
R337	RS14BK2E2003F	Metal film 200k $\Omega$ $\pm$ 1% 1/4W	P304	E40-0201-05	Pin connector 2P
R338	RD14BY2E2R2J	Carbon 2.2 $\Omega$ $\pm$ 5% 1/4W	P305	E40-0403-05	Pin connector 4P
R339	RD14BY2E473J	Carbon 47k $\Omega$ $\pm$ 5% 1/4W	P306, 307	E40-0703-05	Pin connector 7P
R340	RD14BY2E471J	Carbon 470 $\Omega$ $\pm$ 5% 1/4W	P309~311	E40-0332-05	Pin connector 3P
R341	RD14BY2E472J	Carbon 4.7k $\Omega$ $\pm$ 5% 1/4W	-	E23-0047-04	Terminal
R342	RD14BY2E473J	Carbon 47k $\Omega$ $\pm$ 5% 1/4W	-	E33-0867-00	Wire kit
R343	RC05GF2H473J	Carbon 47k $\Omega$ $\pm$ 5% 1/2W	-	F01-0220-04	Heat sink
R344	RC05GF2H275J	Carbon 2.7M $\Omega$ $\pm$ 5% 1/2W	-	F01-0231-14	Heat sink
R345	R92-0708-05	Carbon 15M $\Omega$ $\pm$ 10% 2W	-	F02-0031-05	Heat sink
R346	RC05GF2H226K	Carbon 22M $\Omega$ $\pm$ 10% 1/2W	-	J25-2812-13	Printed circuit board
R347	RD14BY2E473J	Carbon 47k $\Omega$ $\pm$ 5% 1/4W	-	J39-0501-04	Transistor spacer
R348	RD14BY2E222J	Carbon 2.2k $\Omega$ $\pm$ 5% 1/4W			
R349, 350	RD14BY2H104J	Carbon 100k $\Omega$ $\pm$ 5% 1/2W			
R351	RD14BY2E470J	Carbon 47 $\Omega$ $\pm$ 5% 1/4W			
R352	RD14BY2E471J	Carbon 470 $\Omega$ $\pm$ 5% 1/4W			
R353	RD14BY2E681J	Carbon 680 $\Omega$ $\pm$ 5% 1/4W			
R354	RD14BY2E470J	Carbon 47 $\Omega$ $\pm$ 5% 1/4W			
R355	RD14BY2E473J	Carbon 47k $\Omega$ $\pm$ 5% 1/4W			
R356	RD14BY2E472J	Carbon 4.7k $\Omega$ $\pm$ 5% 1/4W			
R357	RD14BY2E103J	Carbon 10k $\Omega$ $\pm$ 5% 1/4W			
R358	RD14BY2E332J	Carbon 3.3k $\Omega$ $\pm$ 5% 1/4W			
R359	RD14BY2E473J	Carbon 47k $\Omega$ $\pm$ 5% 1/4W			
R360	RD14BY2E470J	Carbon 47 $\Omega$ $\pm$ 5% 1/4W			
R361	RD14BY2E223J	Carbon 22k $\Omega$ $\pm$ 5% 1/4W			
R362	RD14BY2E100J	Carbon 10 $\Omega$ $\pm$ 5% 1/4W			
R363	RD14BY2E474J	Carbon 470k $\Omega$ $\pm$ 5% 1/4W			
R364	RD14CY2E121J	Carbon 120 $\Omega$ $\pm$ 5% 1/4W			
-	R92-0150-05	Jumper resistor			
<b>POTENTIOMETER</b>					
VR305	R12-1002-05	Semi-fixed resistor 1k $\Omega$ (B)			
VR306	R12-4502-05	Semi-fixed resistor 68k $\Omega$ (B)			
VR307	R12-3004-05	Semi-fixed resistor 47k $\Omega$ (B)			
VR308	R12-1004-05	Semi-fixed resistor 4.7k $\Omega$ (B)			
VR309	R12-2002-05	Semi-fixed resistor 6.8k $\Omega$ (B)			

# PARTS LIST

## VERTICAL AMPLIFIER BLOCK (X73-1230-00)

Ref. No.	Parts No.	Description	Ref. No.	Parts No.	Description
<b>CAPACITOR</b>					
C101	C90-0021-05	Metal film 0.1μF ±20%	R123	RS14BK2E2001F	Metal film 2kΩ ±1% 1/4W
C102	CM93BD2A330J	Mica 33pF ±5%	R124	RS14BK2E5000F	Metal film 500Ω ±1% 1/4W
C103	CM93BD2A471J	Mica 470pF ±5%	R125	RD14BY2E100J	Carbon 10Ω ±5% 1/4W
C104	CM93BD2A472J	Mica 4700pF ±5%	R126	RD14BY2E224J	Carbon 220kΩ ±5% 1/4W
C105	C91-0503-05	Mylar 4700pF ±5%	R127, 128	RD14CY2E470J	Carbon 47Ω ±5% 1/4W
C106	CC45CH1H101J	Ceramic 100pF ±5%	R129	RD14BY2E181J	Carbon 180Ω ±5% 1/4W
C107	CC45CH1H100D	Ceramic 10pF ±0.5pF	R130, 131	RD14BY2E103J	Carbon 10kΩ ±5% 1/4W
C108	CC45CH1H010C	Ceramic 1pF ±0.25pF	R132, 133	RD14BY2E681J	Carbon 680Ω ±5% 1/4W
C109	C90-0298-05	Semiconductor ceramic 0.1μF +80%, -20%	R134~136	RD14BY2E470J	Carbon 47Ω ±5% 1/4W
C110	CE04W1C470	Electrolytic 47μF 16WV	R137, 138	RS14BK2E3901F	Metal film 3.9kΩ ±1% 1/4W
C111	C90-0298-05	Semiconductor ceramic 0.1μF +80%, -20%	R139, 140	RD14BY2E470J	Carbon 47Ω ±5% 1/4W
C112	CE04W1C470	Electrolytic 47MF 16WV	R141, 142	RD14BY2E682J	Carbon 6.8kΩ ±5% 1/4W
C113	C90-0021-05	Metal film 0.1μF ±20%	R143	RD14BY2E470J	Carbon 47Ω ±5% 1/4W
C114	CM93BD2A330J	Mica 33pF ±5%	R144	RD14BY2E102J	Carbon 1kΩ ±5% 1/4W
C115	CM93BD2A471J	Mica 470pF ±5%	R145	RD14BY2E331J	Carbon 330Ω ±5% 1/4W
C116	CM93BD2A472J	Mica 4700pF ±5%	R146	RS14BK2H9003F	Metal film 900kΩ ±1% 1/2W
C117	C91-0503-05	Mylar 4700pF ±5%	R147	RS14BK2E1113F	Metal film 111kΩ ±1% 1/4W
C118	CC45CH1H101J	Ceramic 100pF ±5%	R148	RS14BK2H9903F	Metal film 990kΩ ±1% 1/4W
C119	CC45CH1H100D	Ceramic 10pF ±0.5pF	R149	RS14BK2E1012F	Metal film 10.1kΩ ±1% 1/4W
C120	CC45CH1H010C	Ceramic 1pF ±0.25pF	R150	RS14BK2H9993F	Metal film 999kΩ ±1% 1/2W
C121	C90-0298-05	Semiconductor ceramic 0.1μF +80%, -20%	R151	RS14BK2E1001F	Metal film 1kΩ ±1% 1/4W
C122	CE04W1C470	Electrolytic 47μF 16WV	R152	RS14BK2H1004F	Metal film 1MΩ ±1% 1/2W
C123	C90-0298-05	Semiconductor ceramic 0.1μF +80%, -20%	R153	RD14BY2E104J	Carbon 100kΩ ±5% 1/4W
C124	CE04W1C470	Electrolytic 47μF 16WV	R154	RD14CY2E471J	Carbon 470Ω ±5% 1/4W
C125	C90-0298-05	Semiconductor ceramic 0.1μF +80%, -20%	R155	RD14CY2E152J	Carbon 1.5kΩ ±5% 1/4W
C126	CK45E1H103P	Ceramic 0.01μF +100%, -0%	R156	RD14BY2E822J	Carbon 8.2kΩ ±5% 1/4W
C127	C90-0298-05	Semiconductor ceramic 0.1μF +80%, -20%	R157	RD14BY2E103J	Carbon 10kΩ ±5% 1/4W
C128	CK45E1H103P	Ceramic 0.01μF +100%, -0%	R158	RD14CY2E221J	Carbon 220Ω ±5% 1/4W
C129	C90-0298-05	Semiconductor ceramic 0.1μF +80%, -20%	R159	-	-
C130	CK45D1H331M	Ceramic 330pF ±20%	R160	RD14CY2E101J	Carbon 100Ω ±5% 1/4W
C131	CK45E1H103P	Ceramic 0.01μF +80%, -20%	R161, 162	RD14BY2E682J	Carbon 6.8kΩ ±5% 1/4W
C132	CC45CH1H121J	Ceramic 120pF ±5%	R163	RD14CY2E101J	Carbon 100Ω ±5% 1/4W
C133	C90-0298-05	Semiconductor ceramic 0.1μF +80%, -20%	R164, 165	RS14BK2E1001F	Metal film 1kΩ ±1% 1/4W
C134	CE04W1A221	Electrolytic 220μF 10WV	R166	RD14BY2E220J	Carbon 22Ω ±5% 1/4W
C135	C90-0298-05	Semiconductor ceramic 0.1μF +80%, -20%	R167	RD14BY2E224J	Carbon 220kΩ ±5% 1/4W
C136	CE04W1C101	Electrolytic 100μF 16WV	R168	RS14BK2E2001F	Metal film 2kΩ ±1% 1/4W
C137	C90-0298-05	Semiconductor ceramic 0.1μF +80%, -20%	R169	RS14BK2E5000F	Metal film 500Ω ±1% 1/4W
C138	CE04W1C101	Electrolytic 100μF 16WV	R170	RD14BY2E100J	Carbon 10Ω ±5% 1/4W
<b>RESISTOR</b>					
R101	RS14BK2H9003F	Metal film 900kΩ ±1% 1/2W	R171	RD14BY2E224J	Carbon 220kΩ ±5% 1/4W
R102	RS14BK2E1113F	Metal film 111kΩ ±1% 1/4W	R172, 173	RD14CY2E470J	Carbon 47Ω ±5% 1/4W
R103	RS14BK2H9903F	Metal film 990kΩ ±1% 1/2W	R174	RD14BY2E181J	Carbon 180Ω ±5% 1/4W
R104	RS14BK2E1012F	Metal film 10.1kΩ ±1% 1/4W	R175, 176	RD14BY2E103J	Carbon 10kΩ ±5% 1/4W
R105	RS14BK2H9993F	Metal film 999kΩ ±1% 1/2W	R177, 178	RD14BY2E681J	Carbon 680Ω ±5% 1/4W
R106	RS14BK2E1001F	Metal film 1kΩ ±1% 1/4W	R179	RD14BY2E470J	Carbon 47Ω ±5% 1/4W
R107	RS14BK2H1004F	Metal film 1MΩ ±1% 1/2W	R180, 181	RS14BK2E3901F	Metal film 3.9kΩ ±1% 1/4W
R108	RD14BY2E104J	Carbon 100kΩ ±5% 1/4W	R182, 183	RD14BY2E470J	Carbon 47Ω ±5% 1/4W
R109	RD14CY2E471J	Carbon 470Ω ±5% 1/4W	R184, 185	RD14BY2E682J	Carbon 6.8kΩ ±5% 1/4W
R110	RD14CY2E152J	Carbon 1.5kΩ ±5% 1/4W	R186	RD14BY2E470J	Carbon 47Ω ±5% 1/4W
R111	RD14BY2E822J	Carbon 8.2kΩ ±5% 1/4W	R187	RD14BY2E102J	Carbon 1kΩ ±5% 1/4W
R112	RD14BY2E103J	Carbon 10kΩ ±5% 1/4W	R188	RD14BY2E331J	Carbon 330Ω ±5% 1/4W
R113	RD14CY2E221J	Carbon 220Ω ±5% 1/4W	R189, 190	RD14BY2E681J	Carbon 680Ω ±5% 1/4W
R114	-	-	R191, 192	RD14BY2E470J	Carbon 47Ω ±5% 1/4W
R115	RD14CY2E101J	Carbon 100Ω ±5% 1/4W	R193, 194	RD14BY2E682J	Carbon 6.8kΩ ±5% 1/4W
R116, 117	RD14BY2E682J	Carbon 6.8kΩ ±5% 1/4W	R195	RD14BY2E331J	Carbon 330Ω ±5% 1/4W
R118	RD14CY2E101J	Carbon 100Ω ±5% 1/4W	R196~198	RD14BY2E470J	Carbon 47Ω ±5% 1/4W
R119, 120	RS14BK2E1001F	Metal film 1kΩ ±1% 1/4W	R199, 200	RD14BY2E682J	Carbon 6.8kΩ ±5% 1/4W
R121	RD14BY2E220J	Carbon 22Ω ±5% 1/4W	H201	RD14BY2E331J	Carbon 330Ω ±5% 1/4W
R122	RD14BY2E224J	Carbon 220kΩ ±5% 1/4W	R202, 203	RD14BY2E470J	Carbon 47Ω ±5% 1/4W
			R204	RD14BY2E152J	Carbon 1.5kΩ ±5% 1/4W
			R205~207	RD14BY2E332J	Carbon 3.3kΩ ±5% 1/4W
			R208, 209	RD14BY2E471J	Carbon 470Ω ±5% 1/4W
			R210	RD14BY2E470J	Carbon 47Ω ±5% 1/4W
			R211	RD14BY2E473J	Carbon 47kΩ ±5% 1/4W
			R212	RD14BY2E104J	Carbon 100kΩ ±5% 1/4W
			R213	RD14BY2E473J	Carbon 47kΩ ±5% 1/4W
			R214	RD14BY2E223J	Carbon 22kΩ ±5% 1/4W
			R215, 216	RD14BY2E470J	Carbon 47Ω ±5% 1/4W
			R217~219	RD14BY2E222J	Carbon 2.2kΩ ±5% 1/4W
			R220, 221	RD14BY2E470J	Carbon 47Ω ±5% 1/4W
			-	R92-0150-05	Jumper resistor

# PARTS LIST

## SWEEP CIRCUIT BLOCK (X74-1090-00)

Ref. No.	Parts No.	Description	Ref. No.	Parts No.	Description
<b>POTENTIOMETER</b>			<b>CAPACITOR</b>		
VR101a, b, VR103a, b	R06-9005-05	Variable resistor 1kΩ (B) 5kΩ (B)	C201	CC45SL1H220J	Ceramic 22pF ±5%
VR105, 106	R12-3004-05	Semi-fixed resistor 47kΩ (B)	C202	CE04W1H010NP	Electrolytic 1μF 50WV
VR107	R12-0060-05	Semi-fixed resistor 330Ω (B)	C203	CQ93M1H102K	Mylar 1000pF ±10%
VR108, 109	R12-3004-05	Semi-fixed resistor 47kΩ (B)	C204	C90-0298-05	Semiconductor ceramic 0.1μF +80%, -20%
VR110, 111	R12-0060-05	Semi-fixed resistor 330Ω (B)	C205	CE04W1H010	Electrolytic 1μF 50WV
VR114	R12-3004-05	Semi-fixed resistor 47kΩ (B)	C206	CE04W1A101	Electrolytic 100μF 10WV
<b>TRIMMER</b>			C207	CQ93M1H223K	Mylar 0.022μF ±10%
TC101	C05-0050-05	Ceramic trimmer 10pF	C208	C90-0298-05	Semiconductor ceramic 0.1μF +80%, -20%
TC102	C05-0049-05	Ceramic trimmer 20pF	C209~211	CE04W1H010	Electrolytic 1μF 50WV
TC103	C05-0050-05	Ceramic trimmer 10pF	C212, 213	CQ93M1H472K	Mylar 4700pF ±10%
TC104	C05-0049-05	Ceramic trimmer 20pF	C214	CE04W1A101	Electrolytic 100μF 10WV
TC105	C05-0050-05	Ceramic trimmer 10pF	C215, 216	CQ93M1H152K	Mylar 1500pF ±10%
TC106	C05-0049-05	Ceramic trimmer 20pF	C217	CC45CH1H101J	Ceramic 100pF ±5%
TC107	C05-0050-05	Ceramic trimmer 10pF	C218	C90-0018-05	Metal film 1μF 100WV
TC108	C05-0049-05	Ceramic trimmer 20pF	C219	C90-0020-05	Metal film 0.01μF 100WV
TC109	C05-0050-05	Ceramic trimmer 10pF	C220	CM93BD2A900J	Mica 90pF ±5%
TC110	C05-0049-05	Ceramic trimmer 20pF	C221	CC45CH1H680J	Ceramic 68pF ±5%
TC111	C05-0050-05	Ceramic trimmer 10pF	C222	CQ93M1H104K	Mylar 0.1μF ±10%
TC112	C05-0049-05	Ceramic trimmer 20pF	C223	CQ93M1H102K	Mylar 1000pF ±10%
TC113, 114	C05-0050-05	Ceramic trimmer 10pF	C224	CC45CH1H680J	Ceramic 68pF ±5%
<b>SEMICONDUCTOR</b>			C225	CM93BD2A220J	Mica 22pF ±5%
Q101~103		FET 2SK30A-O (Idss)	C226	CC45CH1H151J	Ceramic 150pF ±5%
Q104~109		Transistor 2SC535-B	C227	CE04W1E101	Electrolytic 100μF 25WV
Q110~112		FET 2SK30A-O (Idss)	C228, 229	C90-0298-05	Semiconductor ceramic 0.1μF +80%, -20%
Q113M124		Transistor 2SC535-B	C230, 231	CE04W1A101	Electrolytic 100μF 10WV
IC101		IC TD-3472AP	C232	C90-0298-05	Semiconductor ceramic 0.1μF +80%, -20%
IC102		IC TD-3403AP	C233	CK45B1H391K	Ceramic 390pF ±10%
IC103		IC RC733T	C234	CQ93M1H222K	Mylar 2200pF ±10%
D101~108		Diode 1S1555	C235	CK45D2H103M	Ceramic 0.01μF ±20%
D109, 110		Diode 1S1587	C236	C90-0298-05	Semiconductor ceramic 0.1μF +80%, -20%
D111~117		Diode 1S1555	C237	CE04W1C101	Electrolytic 100μF 16WV
TH101		Thermistor SDT-1000	C238	CE04W1C471	Electrolytic 470μF 16WV
<b>MISCELLANEOUS</b>			C239	CE04W1A101	Electrolytic 100μF 10WV
L101, 102	L40-4701-03	Ferri-inductor 47μH	C240~242	C90-0298-05	Semiconductor ceramic 0.1μF +80%, -20%
S101	S32-4007-05	Lever switch	C243	CC45CH1H470J	Ceramic 47pF ±5%
S102a,b,c	S29-3007-05	Rotary switch with VR	C244	CE04W1A101	Electrolytic 100μF 10WV
VR102			C245	CC45CH1H680J	Ceramic 68pF ±5%
S103a~d	S32-4008-05	Lever switch	C246	CE04W1A470	Electrolytic 47μF 10WV
S104a,b,c, VR104	S29-3007-05	Rotary switch with VR	<b>RESISTOR</b>		
S105	S32-4007-05	Lever switch	R201	RD14BY2E104J	Carbon 100kΩ ±5% 1/4W
-	A22-0802-03	Sub panel	R202	RD14BY2E223J	Carbon 22kΩ ±5% 1/4W
-	E04-0002-05	Receptacle type BNC	R203	PD14BY2E101J	Carbon 100Ω ±5% 1/4W
-	E23-0018-04	Soldering lug	R204	RD14BY2E103J	Carbon 10kΩ ±5% 1/4W
-	E23-0047-04	Terminal	R205	RD14BY2E470J	Carbon 47Ω ±5% 1/4W
-	E33-0842-00	Wire kit	R206	RD14BY2E221J	Carbon 220Ω ±5% 1/4W
P101	E40-0303-05	Pin connector 3P	R207	RD14BY2E101J	Carbon 100Ω ±5% 1/4W
P102, 103	E40-0403-05	Pin connector 4P	R208	RD14BY2E152J	Carbon 1.5kΩ ±5% 1/4W
P104	E40-0503-05	Pin connector 5P	R209	RD14BY2E470J	Carbon 47Ω ±5% 1/4W
-	F11-0026-14	Shield case	R210	RD14BY2E102J	Carbon 1kΩ ±5% 1/4W
-	F11-0147-14	Shield case	R211	RD14BY2E103J	Carbon 10kΩ ±5% 1/4W
-	J25-1235-43	Printed circuit board	R212	RD14BY2E222J	Carbon 2.2kΩ ±5% 1/4W
			R213	RD14BY2E103J	Carbon 10kΩ ±5% 1/4W
			R214	RD14BY2E101J	Carbon 100Ω ±5% 1/4W
			R215	RD14BY2E473J	Carbon 47kΩ ±5% 1/4W
			R216, 217	RD14BY2E103J	Carbon 10kΩ ±5% 1/4W
			R218	RD14BY2E473J	Carbon 47kΩ ±5% 1/4W
			R219	RD14BY2E101J	Carbon 100Ω ±5% 1/4W
			R220	RD14BY2E332J	Carbon 3.3kΩ ±5% 1/4W
			R221	RD14BY2E223J	Carbon 22kΩ ±5% 1/4W
			R222	RD14BY2E221J	Carbon 220Ω ±5% 1/4W
			R223	RD14BY2E471J	Carbon 470Ω ±5% 1/4W
			R224	RD14BY2E332J	Carbon 3.3kΩ ±5% 1/4W

# PARTS LIST

Ref. No.	Parts No.	Description	Ref. No.	Parts No.	Description
R225~227	RD14BY2E104J	Carbon 100kΩ ±5% 1/4W	VR206, 207	R12-3002-05	Semi-fixed resistor 10kΩ (B)
R228, 229	RD14BY2E682J	Carbon 6.8kΩ ±5% 1/4W	VR208, 209	R12-0051-05	Semi-fixed resistor 150Ω (B)
R230	RD14BY2E821J	Carbon 820Ω ±5% 1/4W	VR210	R12-1003-05	Semi-fixed resistor 2.2kΩ (B)
R231	RD14BY2E152J	Carbon 1.5kΩ ±5% 1/4W	VR211	R12-3004-05	Semi-fixed resistor 47kΩ (B)
R232	RD14BY2E103J	Carbon 10kΩ ±5% 1/4W	VR212	R12-1003-05	Semi-fixed resistor 2.2kΩ (B)
R233	RD14BY2E682J	Carbon 6.8kΩ ±5% 1/4W	TC201	C05-0050-05	Ceramic trimmer 10pF
R234	RD14BY2E221J	Carbon 220Ω ±5% 1/4W	TC202	C05-0064-05	Ceramic trimmer 50pF
R235, 236	RD14BY2E222J	Carbon 2.2kΩ ±5% 1/4W	<b>SEMICONDUCTOR</b>		
R237	RD14BY2E332J	Carbon 3.3kΩ ±5% 1/4W	Q201		Transistor 2SC458-C
R238	RD14BY2E102J	Carbon 1kΩ ±5% 1/4W	Q202, 203		Transistor 2SC535-B
R239	RD14BY2E101J	Carbon 100Ω ±5% 1/4W	Q204, 205		Transistor 2SC458-C
R240	RD14BY2E474J	Carbon 470kΩ ±5% 1/4W	Q206		FET 2SK30A-GR
R241	R92-0709-05	Carbon 3MΩ ±1% 1/4W	Q207~210		Transistor 2SC458-C
R242	RS14BK2H1004F	Metal film 1MΩ ±1% 1/2W	Q211		Transistor 2SA733-Q or R
R243	RS14BK2H5003F	Metal film 500kΩ ±1% 1/2W	Q212		Transistor 2SC458-C
R244	RS14BK2E3003F	Metal film 300kΩ ±1% 1/4W	Q213		Transistor 2SA733-Q or R
R245, 246	RS14BK2E1003F	Metal film 100kΩ ±1% 1/4W	Q214, 215		Transistor 2SC458-C
R247	RD14BY2E222J	Carbon 2.2kΩ ±5% 1/4W	Q216		FET 2SK30A-GR
R248	RD14BY2E101J	Carbon 100Ω ±5% 1/4W	Q217~223		Transistor 2SC458-C
R249	RD14BY2E473J	Carbon 47kΩ ±5% 1/4W	Q224, 225		Transistor 2SC1507
R250	RD14BY2E101J	Carbon 100Ω ±5% 1/4W	IC201		IC TD-3400AP
R251	RD14BY2E103J	Carbon 10kΩ ±5% 1/4W	IC202		IC TD-3472AP
R252	RD14BY2E682J	Carbon 6.8kΩ ±5% 1/4W	IC203, 204		IC TD-3400AP
R253	RD14BY2E273J	Carbon 27kΩ ±5% 1/4W	D201~209		Diode 1S1555
R254	RD14BY2E103J	Carbon 10kΩ ±5% 1/4W	L201	L40-1001-03	Ferri-inductor 10μH
R255	RD14BY2E153J	Carbon 15kΩ ±5% 1/4W	L202	L40-2201-03	Ferri-inductor 22μH
R256	RD14BY2E222J	Carbon 2.2kΩ ±5% 1/4W	L203, 204	L40-1205-05	Ferri-inductor 1mH
R257	RD14BY2E152J	Carbon 1.5kΩ ±5% 1/4W	L205~207	L40-4701-03	Ferri-inductor 47μH
R258	RD14BY2E272J	Carbon 2.7kΩ ±5% 1/4W	L208	L40-2701-03	Ferri-inductor 27μH
R259	RD14BY2E102J	Carbon 1kΩ ±5% 1/4W	<b>MISCELLANEOUS</b>		
R260	RD14BY2E472J	Carbon 4.7kΩ ±5% 1/4W	S201a, b	S32-2012-05	Lever switch
R261	RD14BY2E124J	Carbon 120kΩ ±5% 1/4W	S202a~d	S32-4009-05	Lever switch
R262	RD14BY2E104J	Carbon 100kΩ ±5% 1/4W	S203a~d, VR203	S29-2017-05	Rotary switch w/VR
R263	RD14BY2E472J	Carbon 4.7kΩ ±5% 1/4W	—	A22-0803-13	Sub panel
R264	RD14BY2E470J	Carbon 47Ω ±5% 1/4W	J201	E13-0011-05	Pin jack (CAL)
R265	RD14BY2E223J	Carbon 22kΩ ±5% 1/4W	J202	E21-0209-03	Pair terminal (EXT-TRIG)
R266, 267	RD14BY2E152J	Carbon 1.5kΩ ±5% 1/4W	P201	E40-0403-05	Pin connector 4P
R268	RD14BY2E682J	Carbon 6.8kΩ ±5% 1/4W	P202	E40-0603-05	Pin connector 6P
R269	RD14BY2E153J	Carbon 15kΩ ±5% 1/4W	P203	E40-0503-05	Pin connector 5P
R270	RD14BY2E102J	Carbon 1kΩ ±5% 1/4W	P204	E40-0703-05	Pin connector 7P
R271	RD14BY2E222J	Carbon 2.2kΩ ±5% 1/4W	—	E23-0046-04	Terminal
R272	RD14BY2E682J	Carbon 6.8kΩ ±5% 1/4W	—	E23-0047-04	Terminal
R273	RD14BY2E103J	Carbon 10kΩ ±5% 1/4W	—	E31-0533-05	Lead wire with connector
R274	RD14BY2E101J	Carbon 100Ω ±5% 1/4W	—	E33-0843-00	Wire kit
R275	RD14BY2E222J	Carbon 2.2kΩ ±5% 1/4W	—	G53-0015-14	Antenna bush
R276	RD14BY2E102J	Carbon 1kΩ ±5% 1/4W	—	J25-1236-43	Printed circuit board
R277, 278	RD14BY2E101J	Carbon 100Ω ±5% 1/4W			
R279, 280	RD14BY2E103J	Carbon 10kΩ ±5% 1/4W			
R281, 282	RD14BY2E101J	Carbon 100Ω ±5% 1/4W			
R283	RD14BY2E102J	Carbon 1kΩ ±5% 1/4W			
R284	RD14BY2E472J	Carbon 4.7kΩ ±5% 1/4W			
R285	RS14BK2E5490F	Metal film 549Ω ±1% 1/4W			
R286, 287	RS14GB3F123G	Metal film 12kΩ ±2% 3W			
R288, 289	RD14BY2E221J	Carbon 220Ω ±5% 1/4W			
R290	RD14CY2E820J	Carbon 82Ω ±5% 1/4W			
R291	RD14BY2E101J	Carbon 100Ω ±5% 1/4W			
R292	RD14BY2E221J	Carbon 220Ω ±5% 1/4W			
R293	RD14CY2E820J	Carbon 82Ω ±5% 1/4W			
R294	RD14BY2E223J	Carbon 22kΩ ±5% 1/4W			
R295	RD14BY2E472J	Carbon 4.7kΩ ±5% 1/4W			
R296	—	—			
R297, 298	RD14CY2E101J	Carbon 100Ω ±5% 1/4W			
R299, 300	RD14CY2E471J	Carbon 470Ω ±5% 1/4W			
—	R92-0150-05	Jumper resistor			
VR201, ) S205	R01-4024-05	Variable resistor 50kΩ (B) w/SW			
VR202, ) S204	R01-2012-05	Variable resistor 5kΩ (B) w/SW			
VR204	R12-1004-05	Semi-fixed resistor 4.7kΩ (B)			
VR205	R12-3004-05	Semi-fixed resistor 47kΩ (B)			

# PARTS LIST

## VOLTAGE SELECTOR UNIT (X77-1020-01)

Ref. No.	Parts No.	Description
-	E08-1081-05	Voltage selector (Receptacle)
-	E09-0681-05	Voltage selector (Plug)
-	E23-0047-04	Terminal
-	E40-0233-05	Connector 2P
-	E40-0533-05	Connector 5P
-	E40-0635-05	Connector 6P
-	F19-0703-04	Changeover switch plate
-	J21-0501-04	Mold pin
-	J21-2824-04	Selectro mounting hardware
-	J25-2805-14	Printed circuit board



---

A product of  
**TRIO-KENWOOD CORPORATION**

6-17, 3-chome, Aobadai, Meguro-ku, Tokyo 153, Japan

---

© 8491 PRINTED IN JAPAN B51-1008-00 (T)



**SCHEMATIC DIAGRAM**

